

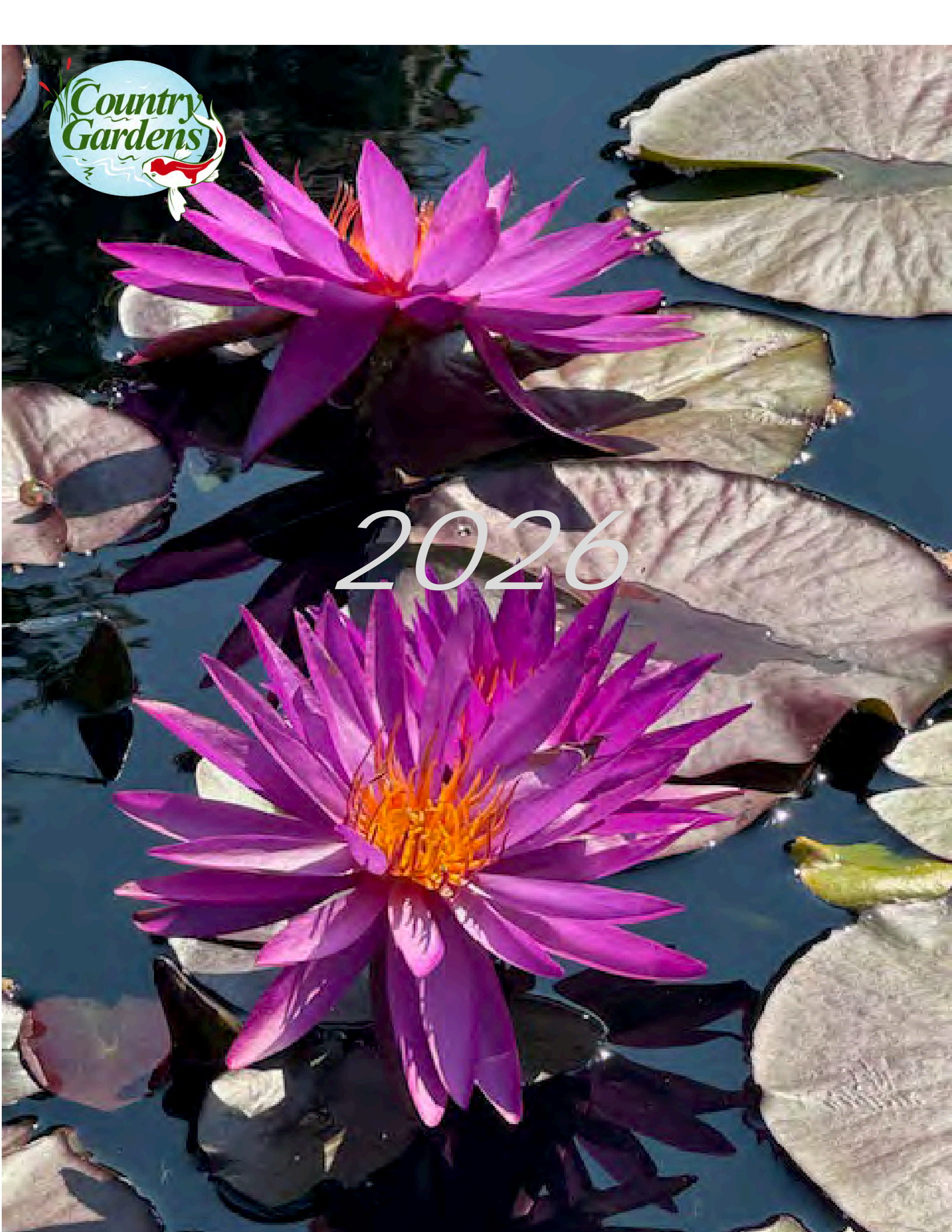

2026



It is important to keep in mind that water gardening is rapidly growing. New trends and products are introduced all the time. In order to keep you updated when you can't make it in, we have 3 electronic ways to get information from us:

Our webpage & Online Store

www.countrygardens-rowley.com

Our email newsletter

sign up from the link on our web page or at the cash register

Country Gardens Water Garden Specialist Facebook Page.

Link is on our web page



Web Page



Instagram Page

New products are coming in all the time so be sure to stop by and see our complete water gardening line.

We also offer the plumbing supplies to get your pond started and keep it running.

All prices in this catalog are based on current market conditions and are subject to change.

Table of Contents

Cross Section of a Pond	Page 5
Flexible Liners	Page 6
Underlay	Page 7
Installing a Flexible Liner	Page 8
Preformed Pools	Page 9
Installing a Preformed Pond	Page 10
Patio Ponds	Page 11
Pumps	Page 12
Submersible Pumps	Page 13
Check Valves	Page 14
Tubing	Page 18
External Pumps	Page 18
Filters	
Submersible	Page 19
All In One	Page 19
Replacement Media	Page 20
Pressurized Filters	Page 21
Eazy Pod & K+	Page 22
Cetus Sleeve & Nexus	Page 23
Filters as part of waterfall	Page 24
Skimmers	Page 26
Auto Fill Valve	Page 27
Pond Free Systems	
Vaults	Page 28
Reservoir cubes	Page 29
Waterfall Weir	Page 29
Ultra Violet Light	Page 31
Underwater Lights	Page 33
Disappearing Fountain	
Basin	Page 35
Brass Fountains	Page 36
Basalt Rocks	Page 37
GFRC Bubbling Rocks	Page 38
Twister & Bowl Fountains	Page 39
Faux Urns, Spheres & Walls	Page 40
The Balanced Pond	Page 41
The Nitrogen Cycle	Page 42
Water Lilies	Page 43
Lotus	Page 44
Hardy Marginal Plants	Page 45
Tropical Marginal Plants	Page 46



Web Page

continued on next page

www.countrygardens-rowley.com

Floating Plants	Page 47
Submerged Plants	Page 47
Fish	Page 48
Fish Food	Page 50
Water Clarity & Fish Care	
Water Conditioners	Page 52
Phosphate Control & Carbon	Page 53
Algae Control	Page 54
Barley	Page 55
Flocculants	Page 56
Biological Bacteria, Liquid	Page 57
Biological Bacteria, Dry	Page 58
Aqua Defend	Page 59
Cool Water Bacteria	Page 59
Fish Medication	Page 60
Water Enhancements for Fish	Page 61
Accessories	
Test Kits	Page 62
Plant Supplies	Page 62
Fish & Pond Nets	Page 64
Winter/Fall Supplies	Page 65
Aeration Kits	Page 66
De-Icer	Page 67
Pond Maintenance	Page 68
Pond Construction	Page 68
Diverters & Fountains	Page 69
Water Movement	Page 70
Earth Bottom Pond & Lake Treatments	Page 71
Pond Accents	Page 73
Directions	Page 74

Shop Online

www.countrygardens-rowley.com



Instagram

Cross Section of a Pond

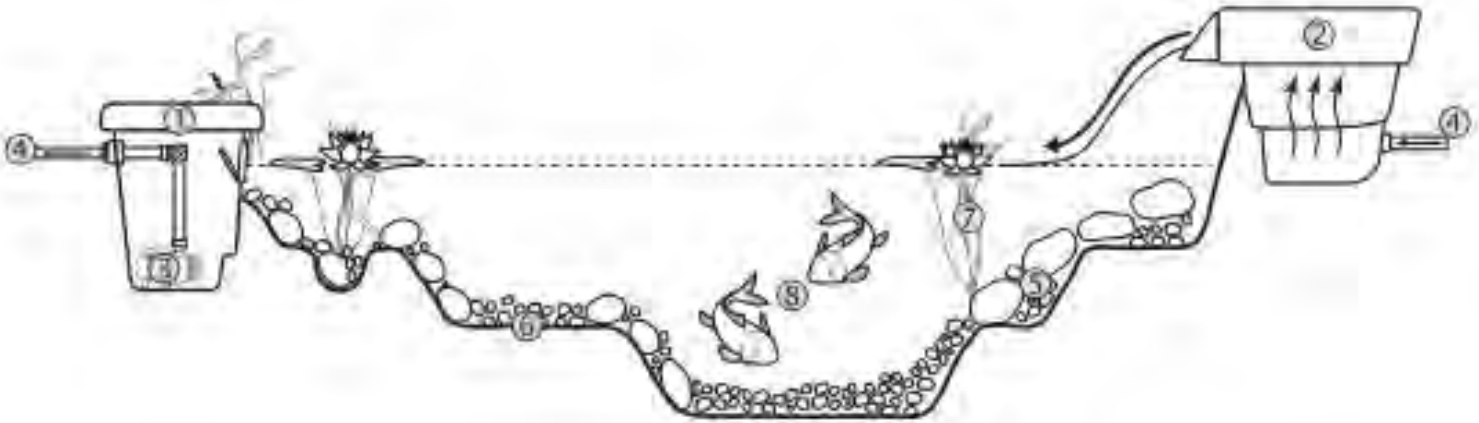

1. **Pond Skimmer** – Pre-filters water and houses pump, collects debris and reduces maintenance. A filter pad or set of brushes collect debris before it reaches the pump. Regular cleaning is necessary to enable water flow. Size is determined by flow of pump and surface area of the pond. See pages 26-27
2. **Biofalls Filter** – Provides surface area for beneficial bacteria to colonize and remove excess nutrients from the water. Fed by the pump, the water flows up through filter media and gravity fed back to the pond. Can be set back from the pond and flow through streambed. Annually cleaning in either the spring or the late fall is typical. See pages 23-25
3. **Pond Pump** – Pumps water from the pond skimmer to the biofalls filter. The size of the pump can be determined on page 12. Often a check valve is used to prevent water from flowing back into the pond from the biofalls when the pump is turned off. Pump options on pages 12-18
4. **Pipe** – Directs water from the skimmer to the biofalls filter. The size of the pipe should be determined by the flow rate of the pump, see page 18. Ideally all water should drain from the pipe in the winter to prevent freezing and cracking. If installation is such that water does not automatically drain from the pipe, it should be blown out.
5. **Rocks and Gravel** – Naturalizes the pond and provides surface area for beneficial bacteria to grow and break down excess nutrients. Can help to protect the liner, however, the use of too much rock and gravel will trap organics and make maintenance more difficult. Excess organic material can result in poor water quality and poor fish health. Regular cleaning and the use of beneficial bacteria will help to minimize these effects.
6. **Pond Liner and Underlay** – Forms the pond's foundation for containing the water and allowing for gases to escape from beneath the pond. A fish safe 45 mil EPDM rubber is the most common material used. The fabric underlay will help prevent sharp objects (rock, roots) from penetrating the rubber liner. Underlay can also be used between the liner and larger rocks inside the pond for extra protection. See pages 6-7 for sizes.
7. **Plants** – Filter pond water, thereby minimizing maintenance and improving water conditions. Use nutrients in the pond helping to starve out unwanted algae. Provide fish with shade and shelter from some predators. Floating, marginal and deep water plants can combine for a natural setting in the pond, see pages 41-47.
8. **Fish** – Provide nutrients for pond plants. Fish are the life of the pond and provide a great way to interact with it. Koi and comets are the most colorful pond fish – each suited to a particular size and style of pond, see pages 48-49.

Options such as UV lights, Pressure Filters, Underwater Lights, Bubbling Rocks, Vases and more available

Flexible Liners

Although a depth of 30" is ideal for over-wintering fish in this area, an 18"-24" deep pond makes an excellent fish pond and water garden. Finished sizes for 24" deep ponds made with a flexible liner may be estimated simply by subtracting 7' from each liner dimension. This will include a 1 foot stone shelf all around the pond to hide the liner and 6" of buffer liner around the entire pond.

EPDM Pool Liners

EPDM is a synthetic rubber that offers the ideal combination of durability and affordability for lining garden ponds. EPDM rubber (Ethylene Propylene Diene Monomer) has long been known for its outstanding weathering properties and it has been exposed to direct sunlight over long periods of time. It will withstand permanently ponded water.

Liner Size	(24" depth) Finished Pond	*Max Gallons	Price
10'x10'	3'x3'	134	\$170
10'x15'	3'x8'	359	\$255
10'x20'	3'x13'	583	\$340
10'x25'	3'x18'	807	\$425
10'x30'	3'x23'	1032	\$510
10'x50'	3'x43'	1930	\$850
15'x15'	8'x8'	957	\$382.50
15'x20'	8'x13'	1555	\$510
15'x25'	8'x18'	2154	\$637.50
15'x30'	8'x23'	2752	\$765
15'x50'	8'x43'	5146	\$1275
20'x20'	13'x13'	2528	\$680
20'x25'	13'x18'	3500	\$850
20'x30'	13'x23'	4473	\$1020
20'x40'	13'x33'	6417	\$1360
20'x50'	13'x47'	9140	\$1700
25'x25'	18'x18'	4847	\$1062.50
25'x30'	18'x23'	6193	\$1275
25'x50'	18'x43'	11,579	\$2125
30'x30'	23'x23'	7914	\$1530
30'x50'	23'x43'	14,795	\$2550

Liner cut in 5' increments
Ask about additional sizes
available \$1.70 per square foot



Elevate PondGard

- 45 mil
- Easily installed
- Flexible for creative designs
- Specially formulated for water gardening projects
- Safe for fish and plant life
- Contains no migrating plasticizers - which means no cracking or splitting
- Resistance to UV exposure, ozone, frost, snow and extreme temperatures

*Max gallons is if a perfect rectangle.

Waterfall Tips

- Be sure to overlap the water fall liner into the pond
- Provide plenty of support along the walls of the waterfall
- Be sure the liner is beneath all rocks in the waterfall
- Use a combination of sizes of stone for a more natural looking waterfall.

<u>Waterfall Liner</u>	<u>EPDM Price</u>
5'x5'	\$42.50
5'x10'	\$85
5'x15'	\$127.50
5'x20'	\$170
5'x25'	\$212.50
5'x30'	\$255
5'x35'	\$297.50
5'x40'	\$340
5'x45'	\$382.50
5'x50'	\$425
5'x100'	\$850

Liner Repair Kit - \$37.99

Patch kit from Firestone includes two 6"x6" patches, a 2 ounce bottle of Quick Prime, roller, scrubber pad, disposable gloves and instructions.



Liner Underlay

Liner Underlay will help prevent damage to pool liners by rocks and sharp stones. It is a thick non-woven polyester that is ideal for protecting synthetic rubber pond liners from abuse.

<u>Size</u>	<u>Price</u>	<u>Size</u>	<u>Price</u>
5'x5'	\$11.25	10'x10'	\$45
5'x10'	\$22.50	10'x15'	\$67.50
5'x15'	\$33.75	10'x20'	\$90
5'x20'	\$45.00	10'x25'	\$112.50
5'x25'	\$56.25	10'x30'	\$135
5'x30'	\$67.50	10'x35'	\$157.50
5'x35'	\$78.75	10'x40'	\$180
5'x40'	\$90.00	10'x45'	\$202.50
5'x45'	\$101.25	10'x50'	\$225

*Protect your
liner for just
\$0.45 per
square foot*

Full Roll Discounts
5'x360' \$729
10'x360' \$1458



Heavy Duty Pond Underlay

Aquascape Heavy-Duty Pond Underlayment Roll is approximately 30% thicker than standard underlayment. This thicker underlayment provides superior protection from excavations that are riddled with rocks, roots, and hard, uneven soils surfaces that may damage the liner. Although it is thicker, the Heavy-Duty Underlayment still spreads easily, and has a non-slippery surface, making installation quick and easy. The soft geotextile is made from polypropylene and allows for any gases to escape properly, rather than becoming trapped beneath the liner. 15'x100' \$499.99

Rock Sling

The Heavy-Duty Rock Pad Sling makes moving and placing heavy rocks easier during water feature installations. Made of extra-thick, geotextile fabric, the pad protects your liner when moving rocks and can be left under boulders for long-term protection. With six integrated hand holes, two to four people can haul rocks up to 500 pounds to position them safely and accurately. The hand holes can also be fitted with lifting straps, making the Heavy-Duty Rock Pad Sling perfect for use with machinery. You can also use the sling to transport smaller cobbles for building rock walls, waterfalls, or any part of the water feature. 10 pack \$99.99

To figure your liner size

Pond Length	13'	_____	Pond Width	8'	_____
Depth x 2	4'	_____	Depth x 2	4'	_____
Stone Shelf Width	2'	2	Stone Shelf Width	2'	2
Stone Shelf Depth	1'	1	Stone Shelf Depth	1'	1
	-----	-----		-----	-----
Liner Length	20'	_____	Liner Width	15'	_____

Must be in 5' increments to order liner

Installing a Flexible Liner

1. Lay out desired pool shape with garden hose or other flexible material.
2. Excavate pool to desired depth. Be sure to include a stone shelf around the perimeter large enough to accommodate the size stones you have chosen. Side walls should not exceed a 33 degree slope. Remove all sharp objects from excavation. Add 2 to 3 inches of sand or a liner underlay to cushion the bottom and side walls. Be sure the pond is level across the top.
3. Lay the liner in the excavated site, trying to remove the wrinkles as you go. Once the water is in, the weight of the water will prevent you from smoothing out the liner. Begin building your stone perimeter and adding stone on the bottom of the pond if desired. Do not trim away any excess liner until the job is finished.
4. Any waterfall construction or plumbing features is better done before water is added to the pond. If your waterfall is made from flexible liner, be sure to leave a 1'-2' overlap down into the pond to help prevent leaks. Plumbing that requires through the liner insertion should be sealed to the liner and left to dry before coming in contact with the water.
5. When the rocks, waterfall and plumbing are in place you may begin filling with water and finishing around the pond.

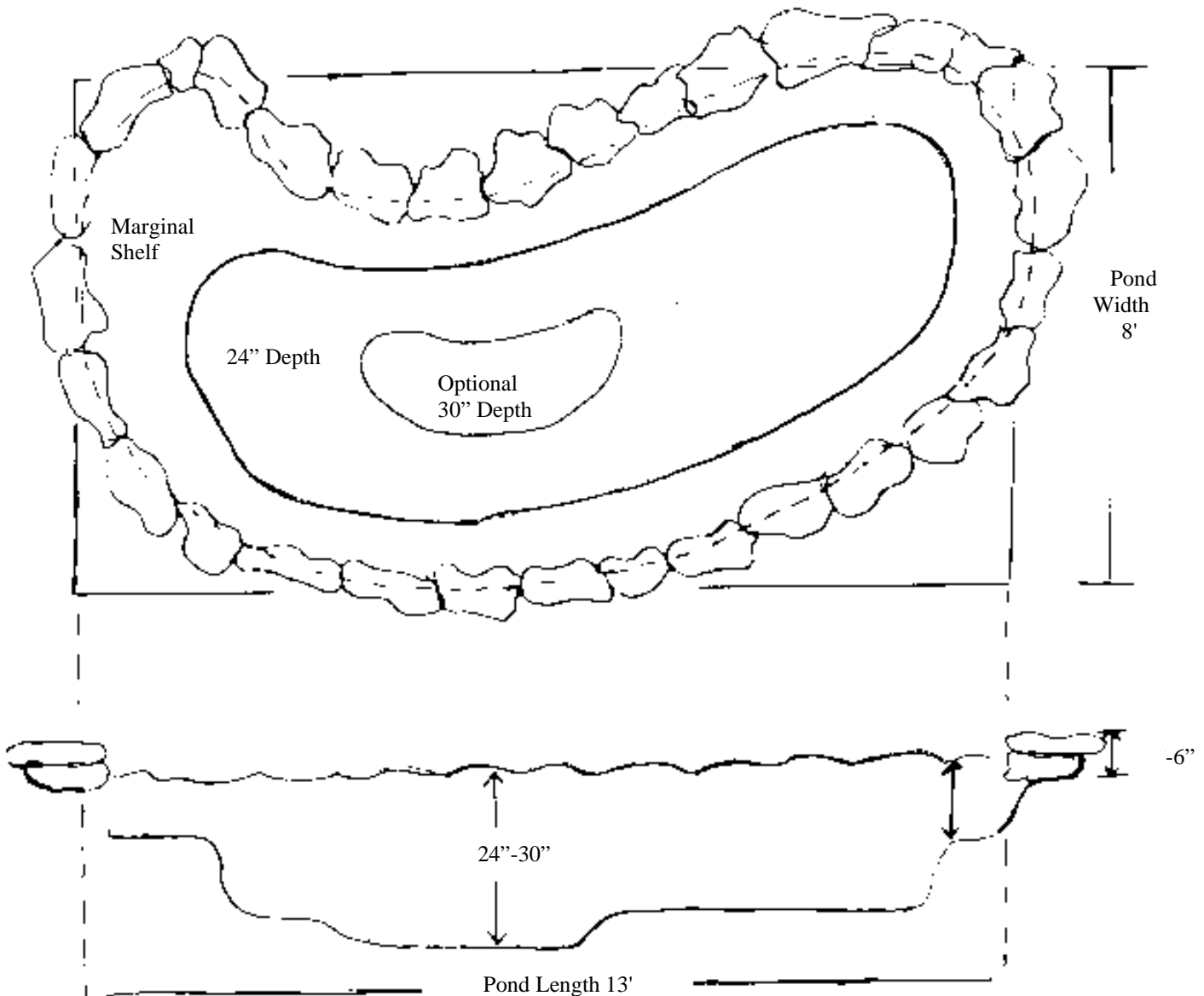

Preformed Ponds

Preformed Polyethylene Ponds

Windermere
133 gallons
74" x 51" x 22"
\$199.99



Ennerdale
91 gallons
67" x 48" x 18"
\$169.99



Coquetdale
31 gallons
44" x 32" x 13" -
\$99.99



Rectangle
75 gallons
31" x 46" x 16"
\$189.99



Country Gardens
(978)948-2124

Wine Barrel
35 gallons
29" diameter, 13.5" depth
\$55.99



Whiskey Barrel Liner
20 gallons
26" diameter, 15" depth - \$75.99
With spillway \$79.99



Steps for Installing a Preformed Pond

1. Select the prefabricated shell.
2. Measure and outline the excavation.
3. Excavate the site.
4. Line the bottom with sand.
5. Level the bottom.
6. Install and fill the shell and backfill around the sides with soil, being sure the pond stays level.
7. Add edging or coping.

Use a garden hose to map out the outline of your water garden before digging. Make the excavation 2 inches wider than the outline.



Use a spirit level to check that the sand covered bottom is level. Check again after the pond has been set in to be sure that it is level.

Simultaneously fill the pond while backfilling the outside to keep the pond from shifting.



Patio Ponds

Aquatic Patio Ponds

Aquascape Aquatic Patio Ponds make it simple to have a complete water garden in almost any setting. Creating a beautifully planted water bowl or container water garden has never been easier. Aquascape Aquatic Patio Ponds have all the natural beauty of real rock with the added durability and light weight of fiberglass. Can be used indoors or outdoors.

Round 24" - \$429.99

Round 32" - \$439.99



Poly-resin fountain work

Great with patio ponds.

Pouring Bamboo 79.99

Deer Scarer \$89.99

Pouring Three Tiered \$79.99

Lazy Frog on Lily Pad \$79.99

**see page 74 for more options



Pump and Filter Combo



Complete solution for small to medium-size container water gardens or any containers with stagnant or non-moving water. Magnetically driven or mag drive motor technology is simple and easy to maintain. Extremely energy-efficient. Durable pre-filter water intake design prevents clogging and reduces pump maintenance. \$36.99



Aquatic Patio Pond Kit

Add the beauty of water to your garden, deck, patio or balcony. Kit includes 16" Square Textured Gray Slate Patio Pond, Pouring Bamboo Fountain and Pump (plants sold separately) \$199.99

AquaGarden Mini Pond Kit

Simple and easy to add the sights and sounds of a water garden to any location. If desired, a few small fish and a wide variety of plants can be added to create your very own one-of-a-kind aquatic paradise. A durable injection-molded construction features a rippled, textured finish and is lightweight and durable for a long-lasting, easy-to-install design. The kit includes all media and substrate needed, including expanded clay grow/biological media and decorative gravel for both the waterfall and pond.

23.5" diameter and 9 7/8" tall. \$189.99 Stand sold separately 16" tall - \$89.99

Plant Light sold separately \$89.99

Tabletop version \$89.99 (11.5" diameter x 5" tall container)



Pumps

MOST IMPORTANT NUMBER TO KNOW ABOUT YOUR POND IS THE NUMBER OF GALLONS

*To find the number of gallons in a pond
(Measurements should be in feet. There are 7.48 gallons of water per cubic foot.)*

*For a rectangle: Length x Width x Depth x 7.48 = Gallons in pond
For irregular shapes: use the rectangle measurement and multiply by 80%
For a Circle: $3.14 \times (1/2 \text{ diameter} \times 1/2 \text{ diameter}) \times \text{depth} \times 7.48 = \text{Gallons in pond}$*

Pump Sizing

1. You should circulate 1/2 the volume of the pond in 1 hour. For every 1" of waterfall width you will need approximately 100 GPH of water
2. Take into consideration the vertical lift your pump will push the water to get to the top of the waterfall.
3. Every 10' of horizontal movement is equal to 1 vertical foot. Place your pump as far from the water return as possible to maximize circulation.
4. Keep in mind limitations of skimmers, filters, and tubing sizes.
5. Use the pump that fits the largest of the above equations but operates in its optimal range on curve as indicated to by gray shading.

Example – You have a 1500 gallon pond with a waterfall that is 36" wide. The vertical rise is 3' from the pond to the top of the waterfall, but you are running it through 20' of tubing.

Answer - The 1500 gallon pond would use a pump that is 750 gallons, but to get a nice flowing waterfall you will need a pump that puts out 3600 gph (36"x 100 gph) at a vertical height of 5' (3' vertical plus 2' for the horizontal of 20'). You could choose the Easy Pro TH250 pump or the Atlantic TT5000 to satisfy the flow rate - ***however, the Th250 requires 10' of head pressure to operate efficiently so the TT5000 is the better choice. (see charts on pages 16-17)

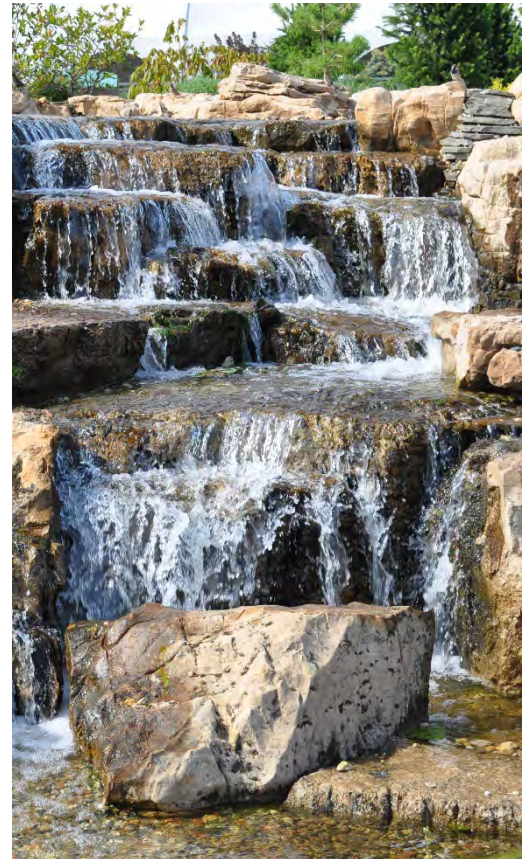

Why should I circulate my water?

1. To add oxygen to the pond

As temperatures rise, dissolved oxygen levels in water decrease. During the summer months, plants alone cannot supply fish, especially large fish, with enough oxygen in a closed system such as a water garden. Other organisms, such as the nitrifying bacteria in your biological filter, also will need added oxygen. A waterfall, statuary or fountain will add oxygen to the water each time the water returning to the pond breaks the surface of the pond.

2. To reduce stagnant water

Stagnant water is a breeding ground for mosquito larvae. Mosquitoes will not lay eggs in moving water, however, if you are not circulating your pond water, they will breed. Also, motionless water can create a foul odor and algae usually develops quicker.

Winter Tip

Do not leave your pump in a skimmer box during the winter months. Disconnect it, clean it, drain it, and store it for winter indoors.

Submersible Pumps

Atlantic Pumps

Tidal Wave MD Series

These magnetic induction pumps are perfect choice for small water features with low head heights. Hefty and heavy duty, equipped with removable pre-filters, oversize ceramic shafts, replaceable impeller assemblies. Great energy efficiency and a five year warranty. Oversized male threaded inlet and outlet for less restriction and greater flow. Rotating volute provides maximum adaptability for any installation. Quarter twist volute provides access to the impeller assembly without the use of tools. Large, stable base is removable. Removable pre-filter provides increased surface area and reduces maintenance. Tapered outlet fittings accept a wide array of tubing sizes. MD1000-MD2000 include a 1 1/2" adapter for use with the Triton Check Valve and Fountain Basin Plumbing Kits. 20' power cord.

	<u>Pump</u>	<u>Replacement Impeller</u>	<u>Replacement Intake Kit</u>
MD 250	\$103.99	\$20.99	\$24.99
MD550	\$121.99	\$24.99	\$24.99
MD750	\$137.99	\$25.99	\$24.99
MD1000	\$241.99	\$85.99	\$19.99
MD1250	\$271.99	\$107.99	\$19.99
MD1500	\$343.99	\$134.99	\$21.99



TidalWave 3 Series

The next generation of ultra-high efficiency asynchronous pumps, with more water moved per watt than ever before. Remarkably compact to fit in the tightest spaces. Specifically designed to be clog resistant and hard water tolerant. Large threaded inlet and outlet for less restriction and greater flows. Quarter turn volute provides access to impeller without the use of tools. Heavy duty pre-filter locks in place. Large openings and increased surface area resist clogging. Three van hybrid impeller improves flows and passes solids easily. 20' power cord and 3 year warranty.

	<u>Pump</u>	<u>Replacement Impeller</u>	<u>Replacement Intake Kit</u>
TT1500	\$293.99	\$62.99	\$20.99
TT2000	\$325.99	\$63.99	\$20.99
TT3000	\$389.99	\$64.99	\$20.99
TT4000	\$553.99	\$100.99	\$24.99
TT5000	\$618.99	\$104.99	\$24.99
TT6000	\$682.99	\$107.99	\$24.99
TT7500	\$877.99	\$119.99	\$34.99



Hints for keeping your pumps running smoothly

1. Use a pre-filter on inlet to catch debris before it gets into the impeller.
2. Clean around the impeller area when you clean the pre-filter. This will alert you to any problems with debris going through the pre-filter and into the pump.
3. Do not run your pump out of the water. Most submersible pumps are water cooled, and overheating them by running them without water may damage the pump.
4. Do not lift your pump in and out of the pond using the electrical cable. Continuous strain on this cable may cause short-circuiting or could break the seal around it.
5. Do not break the seals on the pump, this will void the warranty. Do not remove or alter the electrical cord in any way as this will also void the warranty.

Be sure to keep your receipt and box your pump came in. In the event that the pump malfunctions within the warranty period, you will need these.

Country Gardens
(978)948-2124



Easy Pro Pumps

Stainless Steel TH Series

A great choice for ponds, waterfalls, fountains and similar applications.

Compact design is ideal for use in skimmers. Rugged motor – designed for long life, continuous duty operation; motor housing is corrosion-resistant stainless steel. Low maintenance-pump casing is made from abrasion-resistant, fiber reinforced plastic for maximum life. Vortex design prevents clogging. Built-in overload and overheat motor protections.

2" female threaded outlet. 2 year warranty.

TH150	3100 GPH	\$564.99
TH250	4100 GPH	\$674.99
TH400	5100 GPH	\$733.99
TH750	6000 GPH	\$865.99

Optional screen for bottom fits models 2009 and newer \$31.99



HTH Series

Horizontal model of the TH series.

HTH250	5400 GPH	\$709.99
--------	----------	----------



Check Valves

Prevents water loss when pump is shut off

. (Remember to disconnect in the winter)

Easy Pro 2" MPT x 1 1/2" coupling \$79.99

Easy Pro 2" MPT x 2" union \$79.99

Atlantic Universal \$92.99

Aquascape Dual Union \$75.99



PondBuilder Pumps

Magnetic drive pumps that are perfect choice for small water features with low head heights. These heavy duty pumps are equipped with a removable pre-filter, adjustable flow, replaceable ceramic shaft impellers, and a long heavy duty power cord. Operates in-line or submerged. 5 year warranty.

		<u>Cord length</u>	<u>Outlet</u>
120 GPH	\$37.99	6'	1/2"
180 GPH	\$45.99	6'	1/2"
290 GPH	\$79.99	16'	3/4"
370 GPH	\$89.99	16'	3/4"
530 GPH	\$109.99	20'	3/4"
660 GPH	\$134.99	20'	3/4"
800 GPH	\$159.99	20'	3/4"
1110 GPH	\$179.99	20'	1"
1300 GPH	\$199.99	20'	1 1/4"



Rush Mag Drive Pumps

These pumps are typically used on fountains and small ponds. Can be use both submersible and out-of-water. Built in flow control, magnetic driven impeller, energy efficient and quiet. Pump body is heat and stress resistant molded plastic. Thermally protected. 3 year warranty.

XR350	\$114.99
XR750	\$134.99
XR1200	\$239.99



Aquascape Pumps

Aquaforce Series

Asynchronous, solids handling waterfall and filter pumps combine energy efficient performance, high flow rates, and ease of maintenance making this this pump the ideal choice for discriminating pond owners. The protective pre-filter cage allows pump to be placed directly into the pond. Able to pumps solids up to one quarter of an inch, making it ideal for use with eternal pressure filters. Oil-free design, plumbing adapter fittings included.

Aquaforce 1000	\$269.99	Aquaforce 3600	\$399.99
Aquaforce 1800	\$329.99	Aquaforce 5200	\$489.99
Aquaforce 2700	\$349.99		



Limited 3 year warranty

PL Series

Hydraulically dialed into the head pressure found in water garden applications. This helps ensure that the pump is performing in its ideal operating range, resulting in less vibration and wear and tear on the pump, ultimately resulting in longer life. Horizontal design. 20' power cord. 2" FPT outlet. 2 year limited warranty.

3PL	\$669.99
5PL	\$889.99
9PL	\$999.99



SLD Adjustable Flow Series

Solids-handling, asynchronous motor technology provides superior reliability, reduced maintenance. The included Smart Control Receiver includes an integrated control panel and makes it easy to control your pump with the Aquascape Smart Control App, including flow adjustment and customized scheduling. An optional Universal Remote is available separately to allow wireless control without the use of a smartphone or tablet. Limited 3-year warranty.

2000-5000 gph	\$769.99
4000-7000 gph	\$819.99
5000-9000 gph	\$1009.99



Fountain and Statuary Pumps

Perfect for running smaller decorative fountains. Magnetically driven technology is simple and easy to maintain. Extremely energy efficient. Oil-free design prevents pond contamination. Includes flow control valve to create a customized water flow. 6' cord. 3 year limited warranty. 1/2" outlet

<u>Pump</u>	<u>Price</u>	<u>Max Head Height</u>	<u>Watts</u>	<u>Impeller</u>
70 GPH	\$21.99	2'	3.0	\$4.99
90 GPH	\$26.99	3'	4.3	\$4.99
180 GPH	\$36.99	4'	9.3	\$4.99



Shading Indicates Best Head Height Range



Atlantic MD Series

	AMPS	WATT	Gallons per hour at height					Inlet	Outlet	Price
			0'	5'	10'	15'	20'			
MD250	.13	15	300					1"	¾"	\$103.99
MD550	.35	40	650	385				1"	¾"	\$121.99
MD750	.44	50	790	465				1"	¾"	\$137.99
MD1000	.79	90	1080	785	275			1.5"	1"	\$241.99
MD1250	1.05	120	1330	1040	580			1.5"	1"	\$271.99
MD1500	1.44	165	1560	1255	780			1.5"	1"	\$343.99

Atlantic TidalWave 3 Series

	AMPS	WATT	Gallons per hour at height					Outlet	Price
			0'	5'	10'	15'	20'		
TT1500	.8	99	1640	1060	350			1.5"	\$293.99
TT2000	1.1	132	2640	1760	715			1.5"	\$325.99
TT3000	1.4	169	3000	2180	1215	475		1.5"	\$389.99
TT4000	2	238	4490	3330	1785	700		1.5"	\$553.99
TT5000	2.5	300	5150	4255	3170	1615	395	2"	\$618.99
TT6000	2.7	317	6600	4915	3065	1480	265	2"	\$682.99
TT7500	4.4	520	7650	6300	4640	2860	1250	2"	\$877.99

Atlantic Variable Speed Controller

Allows you to vary the output of pump . Wireless control via smartphone or remote.
For use with Atlantic TT series pumps up to 800 watts.
\$244.99



Rush Mag Drive Pumps

	Amps	Watts	Gallons per hour at height					Max	Price
			0'	2'	4'	6'	8'		
XR350	.25	29	400	350	220	100		7.5'	\$114.99
XR750	.52	60	800	725	600	425	250	10'	\$134.99
XR1200	.67	78	1320	1200	1025	800	650	10'	\$239.99

Aquascape Aquaforce Series

	AMPS	WATTS	Gallons per hour at height					Max	Price
			1'	5'	10'	15'	20'		
1000	.51	55	1070	850				10'	\$269.99
1800	1.33	160	2149	1806	1320	260		16.5'	\$329.99
2700	1.25	147	2695	2350	2000			14'	\$349.99
3600	1.8	215	3868	3613	3254	2100		18'	\$399.99
5200	3	360	5284	5000	4600	3500	1600	24'	\$489.99

Shading Indicates Best Head Height Range

*Country Gardens
(978)948-2124*

Pond Builder Pumps

	Amps	Watts	Gallons per hour at height					Max	Price
			0'	4'	8'	10'	20'		
120 GPH	.08	7	120					2.6'	\$37.99
180 GPH	.12	9.5	180					4.7'	\$45.99
290 GPH	.23	16	290	195				5.95'	\$79.99
370 GPH	.40	24	370	225				7.6'	\$89.99
530 GPH	.55	33	530	390				7.92'	\$109.99
660 GPH	.73	43	660	440	200			8.82'	\$134.99
800 GPH	.80	58	798	600	300			9.3'	\$159.99
1110 GPH	.85	92	1110	875	600	350		12.2'	\$179.99
1300 GPH	1	110	1300	1050	800	600	300	13.5'	\$199.99

Mechanical Drive Pumps – Must have proper head pressure to operate efficiently.

Easy Pro Pumps

	Amps	HP	Gallons per hour at height								Max	Price
			1'	5'	10'	15'	20'	25'	30'			
TH150	2.6-3.1	1/4	3100	2760	2100	1380	600			23'	\$564.99	
TH250	3.0-4.2	1/3	4100	3900	3240	2580	1800	900		30'	\$674.99	
HTH250	4.6	1/3	5400	4560	3600	3000	1740	780		28'	\$709.99	
TH400	3.7-6.0	1/2	5100	4980	4380	3600	2760	2040		36'	\$733.99	
TH750	6.0-9.9	1	6000	5880	5460	4980	4380	3720		43'	\$865.99	



Tsurumi Pumps

	Amps	HP	Gallons per hour at height							Max	Price
			5'	10'	15'	20'	25'	30'			
2OM	3.2	1/5	2430	2010	1500	960			23'	\$468.99	
2PU	3.1	1/5	2880	2130	1200				17'	\$525.99	
3PN	4.6	1/3	3630	2760	2400	1800	1080		30'	\$740.99	
4PN	5.8	1/2	4740	4320	3700	3000	2400	1800	44'	\$939.99	
8PN	8.7	1	5520	5400	5340	4800	4200	3600	56'	\$1085.99	

Aquascape PL Series

	AMPS	WATTS	Gallons per hour at height					Max	Price
			1'	5'	10'	15'	20'		
3PL	4.6	328	3300	3000	1800			14'	\$669.99
5PL	5.8	660	5100	5000	4100	3150	1800	22'	\$889.99
9PL	9.7	987	6900	6800	6200	5400	4700	35'	\$1069.99

Smart Control Plug

The Aquascape Smart Control Plug allows you to control and monitor outdoor electronics from your anywhere using your Smart phone or Tablet. Setup is quick and easy. The plug features three outlets so you can control three products simultaneously. Use dynamic scheduling to have products turn on automatically when you need them and get real-time energy consumption data for any electronic device to make informed decisions and save money. The astronomical timer allows the outlets to automatically turn on and off based on your location. The device also works with Alexa for easy voice control. \$69.99

Proper Tubing Sizing

To get (GPH)	Use tubing ID
250	1/2"
700	3/4"
1000	1"
1500	1 1/4"
3000	1 1/2"
5000	2"
9000	3"



This chart indicates the recommended inner diameter of tubing for the maximum gph of the pump.

Sold in 5' increments.

Vinyl

1/4" - \$0.45 per foot
3/8" - \$0.55 per foot
1/2" - \$0.65 per foot

Vinyl

5/8" - \$0.95 per foot
3/4" - \$1.60 per foot
1" - \$2.10 per foot

Flex PVC

1 1/4" - \$2.99 per foot
1 1/2" - \$2.99 per foot
2" - \$3.79 per foot
3" - \$7.39 per foot (*non-stock – must be ordered in 25' increments*)

Metric - 32 mm \$2.79 per foot 38mm \$2.79 per foot

External Pumps

PerformancePro Artesian Pumps

This line of pumps is the perfect choice for efficiency and reliability with the added convenience of safety and self-priming. Molded of corrosion-resistant polypropylene, Artesian pumps are ideal for applications in which the pump is positioned above the water. An easy-open Lexan lid provides ready access to the integral strainer pot's large basket. Pumps have 2" female NPT suction and discharge. Inexpensive to operate. Price includes 8' power cord with 115 volt plug. 3 year warranty

Model	HP	Watts	Gallons per hour at height				Max	Price
			5'	10'	15'	20'		
A2 1/8-39	1/8	198	3420	2520	1140		16'	\$1079.99
A2 1/4-58	1/4	350	5100	4260	3240	1680	22'	\$1159.99
A2 1/3-63	1/3	460	5760	4980	4080	2940	25'	\$1209.99
A2 1/2-76	1/2	620		7200	5760	3600	23'	\$1289.99

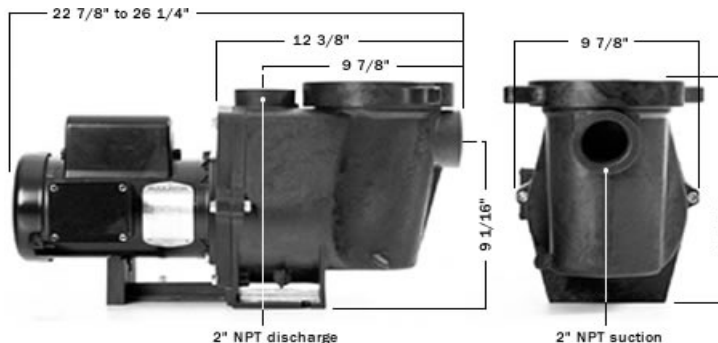

Tips for installing an external pump.

- Keep your pump protected from weather. It should be brought in for winter or else drained.
- Allow adequate space for additional plumbing needed.
- Keep basket clear from debris.
- Use a check valve to avoid air-locking the pump when restarting.
- A pre-filter before the pump will make cleaning easier.

Filters

Pre-filters help to protect your pump and can provide biological filtration as well. Never clean all your filter media at one time. Beneficial bacteria that has been growing in the media will be destroyed by contaminated tap water or cleaning solutions.

Submersible Filters

Matala EZ Bio-Prefilter

Prevents flow reduction due to premature clogging, extends pump life. Connects to many types of pumps and is easily extendable for increased capacity. Minimal maintenance – just rinse with water.

Single \$34.99 Double \$55.99

Refill large green \$26.99 small black \$19.99



Matala Pump Defender

Pump Defenders are designed to protect your submersible water pumps from clogging with debris. The pump sits inside a basket of green density Matala and then wrapped in a nylon bag with drawstring. Heavy debris is filtered out before it reaches the intake of the pump, thereby reducing maintenance and extending the life of the pump.

MPD – 6 6"x10" \$36.99 MPD – 9 9"x13" \$39.99



Tempo Submersible Pond Filter

Provides mechanical and biological filtration. Pump sits under filter pads preventing plugging. Comes complete with dual media – white inner roll provides biological surface area while black surface media traps debris. For ponds up to 600 gallons.

12.5" diameter x 10" tall. Max Flow 850 GPH. Fits tubing sizes 3/4" or 1". \$53.99

Replacement filter media Top \$12.99 Bottom \$15.99



Aquascape Submersible Filter

Provides pond owners with efficient mechanical and biological filtration. This unobtrusive filter can be added to the intake of almost any submersible water pump resulting in clearer water and maintenance-free pumps. Removable cage for easy cleaning. Will handle flow rates up to 1300 GPH Includes 2x3/4", 1", 1.25" multi-hose fitting. \$79.99

Replacement Pad \$39.99 Replacement Ceramic Media \$17.99



Pondmax All in One Submersible Filter

Compact, submersible filter requires no complicated plumbing for dramatically simple filter installation. Built-in UV clarifier enhances pond water clarity by combating green water algae for beautiful, crystal clear water. 20' cord.

SF750 Max flow 660 gph, 9 watt UV, For 375 gallon pond with fish and sun. \$289.99

SF1000 Max Flow 1000 gph, 13 watt UV, For 500 gallon pond with fish and sun. \$369.99

Replacements - UV Bulb (9W) \$39.99

UV Bulb (13W) \$44.99

Filter Pad \$34.99

Quartz Sleeve \$49.99



Pump Sleeve

Protects small submersible pumps from sucking in large debris that may cause pump damage. Easy to clean. Surrounds pump with filter media on side and bottom.

Mini 4.5"x3"x3.5" \$19.99 Small 6"x4"x3.5" \$24.99

Replacement Filter Media

Carbon and Coarse for 190 Pump/filter Kit		\$13.99
Carbon and Coarse for PM1000		\$16.99
Foam for Pondmaster Models 2-7		\$10.99
Aquabelle for Pondmaster Models 2-7		\$16.99
Foam for Pondmaster Models 9-18		\$16.99
Lava Rock		\$9.99
Media Bag		\$13.99
Polyester Foam	12"x12"	\$6.50
2" coarse	12"x18"	\$9.75
	18"x18"	\$14.65
	18"x24"	\$19.50
	24"x24"	\$26.00
	24"x36"	\$39.00
Matala Filter Pad 24"x39"x1.5"		\$49.99
Matala Filter for Mini EP or Elite Skimmer		\$17.99
Matala Filter for Small EP Skimmer		\$18.99
Savio Filter Mater		\$16.99
Savio Skimmer Mat		\$14.99
Savio Compact Skimmer Mat (2 pieces)		\$12.99
Tetra Clearchoice Replacement Pads		\$26.99



Submersible vs. External Filters

Submersible filters work best in smaller ponds. The filter is connected to the intake of the pump and rests on the bottom of the ponds. They are sometimes difficult to pull up and clean on a regular basis, however, they are an excellent protection for you pump and contain enough media for good biological filtration in ponds less than 800 gallons. Submersible filters tend to be less expensive than external.

External filters provide easy access for cleaning. They can usually be camouflaged in the landscape. Due to their size, they provide a larger surface area for better biological filtration. Most external filters, if they are not pressurized, use gravity to move the water back to the pond, therefore, they must be above pond level at the re-entry point. External filters do not protect your pump from clogging, it is recommended that you make use of a pre-filter in the pond for mechanical filtration or keep the pump in a skimmer box for this purpose.

Pressurized External Filters

Pond Max Pressure Filter

Compact and effective filtration system of simple configuration and easy installation. Multiple fittings to adapt to different types of tubing. Low maintenance with cleaning indicator and backwash rinsing system. Double action biological sponges. High surface area bio rings on PF2400, PF3600, PF4800, PF7200 models. Optional ultraviolet clarifier to help maintain clear water.
Inlet/Outlet 3/4" / 1" / 1.25" PF750
Inlet/Outlet 1" / 1.25" / 1.5" PF1200, PF2400, PF3600
Inlet/Outlet 1.25" / 1.5" / 2" PF4800, PF7200



Model	Max Pond Size without fish Shaded	Max Pond Size with fish full sun	Max Flow	UV Size	Price with UV
PF750	750	375	1000 gph	9 watt	\$324.99
PF1200	1200	600	1200 gph	13 watt	\$499.99
PF2400	2400	1200	1800 gph	18 watt	\$599.99
PF3600	3600	1800	3400 gph	24 watt	\$749.99
PF4800	4800	2400	3600 gph	36 watt	\$819.99
PF7200	7200	3600	4000 gph	55 watt	\$979.99



Model	Annual Service Kit	Replacement Filter Pad Set	Replacement Quartz Sleeve	Replacement UV Bulb	UV Transformer
PF750	\$149.99	\$64.99	\$39.99	\$39.99 9 watt	\$139.99
PF1200	\$189.99	\$109.99	\$45.99	\$44.99 13 watt	\$149.99
PF2400	\$214.99	\$134.99	\$49.99	\$54.99 18 watt Older models use 13 watt	\$199.99
PF3600	\$259.99	\$184.99	\$54.99	\$59.99 24 watt Older models use 18 watt	\$224.99
PF4800	\$334.99	\$169.99	\$59.99	\$64.99 36 watt	\$279.99
PF7200	\$414.99	\$229.99	\$79.99	\$69.99 55 watt	\$339.99

Model	Replacement O Ring Kit	Center Tube	Replacement Lid	Replacement Tank	Lid Clamp
PF750	\$20.99	\$44.99	\$129.99	\$49.99	\$24.99
PF1200	\$22.99	\$49.99	\$174.99	\$124.99	\$29.99
PF2400	\$22.99	\$64.99	\$209.99	\$139.99	\$29.99
PF3600	\$22.99	\$69.99	\$234.99	\$159.99	\$29.99
PF4800	\$36.99	\$74.99	\$239.99	\$169.99	\$44.99
PF7200	\$36.99	\$79.99	\$299.99	\$199.99	\$44.99

Model	Ball Valve	Washers	Hosetails	Crank Handle
PF750		\$0.99	\$15.99	\$8.99
PF1200, PF2400, PF3600	\$30.99	\$1.99	\$30.99	\$8.99
PF4800, PF7200	\$34.99	\$1.99	\$39.99	\$11.99

Pressurized Filter vs. Gravity Filter

While a pressurized filter sounds easy there is actually more maintenance involved than a filter that is camouflaged by the waterfall and gravity fed to the pond. The 2 big advantages to a pressure filter are the usually compact size and the fact that it can be hidden anywhere near the pond. However, they must be backwashed on a regular basis to avoid damage to the unit itself. A pressure filter greatly restricts the flow of the pump as it exits back to the pond. Sometimes complex plumbing is required to connect into a system.

Using a gravity filter as the start of your waterfall is easy during initial pond installation but may require some re-construction of the waterfall for existing ponds. These only need to be cleaned a few times throughout the season if they are sized properly for the pond and fish load. The biggest obstacle is the size of gravity filter since it must contain enough filter media to support the biological activity for the pond. Overall a gravity filter is usually less expensive to purchase and has fewer potential problem parts to replace down the road.

Both filters will work best with a pre-filter such as a skimmer box to aid in mechanical filtration

Eazy Pod Filter Complete

Mechanical, biological and ultraviolet filtration

- For the ultimate in clarity and ease of use
- Simple to install, easy to maintain
- Air Pump 70 Kit included
- 18 Watt UV Included

24.4" (w) x 25.8" (h) x 29.1"mm (d)

A compact member of the Nexus family, the EazyPod is a mechanical and biological filter system for ponds up to 2,640 gallons. The EazyPod utilizes static K1[®] Micro, which provides enhanced biological benefits, even when using the EazyPod solely as a mechanical waste filter. \$1599.99

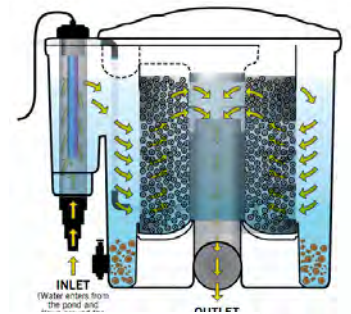

K+ Pressure Filter

- Uses K+ filter media for dramatically improved biological filtration compared to using beads
- Multi-port valve and blower included with all models
- Blower used during cleaning cycle
- Large clear viewing lid on top of the filter



Water is pumped into the filter from the pond through the multi-port valve where the internal pipework directs the water to the bottom of the unit. As the water flows upwards inside the K+ Pressure Filter, dirt, debris and waste are trapped within the mass of K+ filter media. The vast protected surface area provided by K+ Media also provides a home for the beneficial bacteria, along with filter feeders such as Vorticella and Rotifiers delivering mechanical and biological filtration. The filtered water flows back into the pipework at the top of the unit, through the multi-port valve and back down the return line into the pond. The K+ Pressure filter is incredibly easy to clean, by simply moving the handle on the multi-port valve into the corresponding positions to perform a backwash and a rinse of the K+ media.

K+ 3000	\$2099.99	1 ½" ports	max pond volume 3000 gallons
K+ 9600	\$2799.99	2" ports	max pond volume 9600 gallons

Replacement Media K+ 25L \$139.99 50L \$249.99

Cetus Sleeve

Prefilter to remove waste and debris. The Cetus will allow a skimmer or a bottom drain to accept vast amounts of waste without excessive cleaning needed to be carried out. The water must then be pumped to either a normal filter above pond level (Nexus Eazy/Eazy Pod) or to a pressurized filter.

- Easy maintenance
- Reduced backwashing of pressure filters
- Simple installation with flexible connectors
- Patented pondflow regulation system
- Large waste collection which is easy to clean
- Robust one piece mould with no welded joints
- Can be installed on pump or gravity fed set-ups
- 22.6" (w) x 37.2" (h) x 33.9" (d)

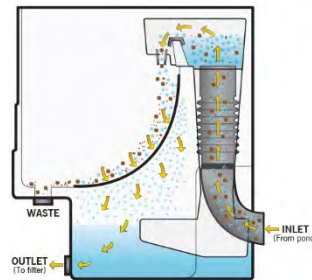

\$1599.99

Nexus+ Filter

The Nexus+ filter is an innovative biological and mechanical filter system in one. Water from the pond enters the Nexus+ via the inlet into the inner chamber which works as a vortex allowing larger solids to settle out. The water then passes through Eazy filter, where fine particles are removed at the mechanical stage of filtration thanks to the static bed of K1 micro filter media. The mechanically clean water then passes to the outside chamber of the Nexus+ where the new K+Media moving bed is located for biological treatment prior to being returned to the pond. At this stage, biological breakdown occurs through different strain of bacteria and filter feeders living on the vast protected surface area of each piece of the K+Media. These bacteria convert Ammonia and Nitrite into less harmful Nitrate. Water then passes through the exit grill into the outlet, returning back to the pond.

Eazy220+ \$2599.99

Eazy320+ \$3299.99

(Nexus+ filters must be ordered - not stocked)

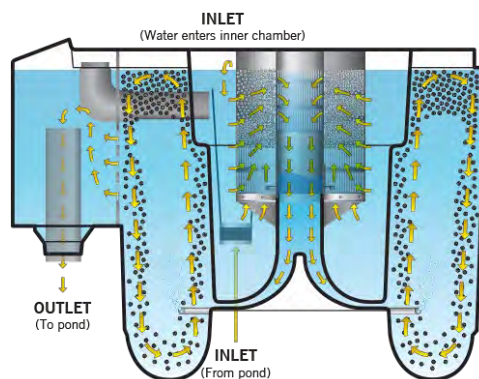

12" Detox Dechlorinator

High capacity, pre-washed carbon removes toxins in tap water. For use on ponds and indoor aquariums. No need to wait for chlorine to "gas-off" or to use liquid treatments. Easily connects to a hose pipe – fittings included. Also can be fitted to rigid pipe.

\$219.99



Filters as part of Waterfall

The bottom of an up-flow gravity filter should be cleaned at least once per year. Solids will settle below the filter pads.

Easy Pro Aquafalls

Aquafalls Filters have an inlet on each side of the filter. Use the one's that's most convenient for your incoming water and simply plug the other hole with a plug (included) or purchase a ball valve and use the second hole as a drain for easier cleaning. These filters have the simulated rock built right into the lip. Simply bolt lip to filter and you're done – no foaming rock lip into place. Aquafalls are buried into the ground making them easy to hide. Built extra strong. Use a grate on the top (sold separately) to even further hide the filter by placing rock over the top.

Model	Inlet Size	Size LxWxH	For Ponds Up To	Waterfall Width	Max Flow	Filter Price
Small	2	26"x26"x26"	2500 gallons	18"	4200 GPH	\$529.99
Medium	2"	35"x36"x28"	6000 gallons	26"	7200 GPH	\$689.99
Large	3"	36"x65"x36"	15,000 gallons	50"	15,000 GPH	\$1498.99

Rock Grate Sold Separately

- Small \$83.99
- Medium \$165.99
- Large \$284.99

Replacement Media

- Small \$23.99 each pad
- Medium \$37.99 each pad
- Large \$65.99 each pad



Pre-drilled holes for 2" bulkhead on each side of Small and Medium Aquafalls

Prelude Filter

Easy and user friendly waterfall filter that requires no tools to attach liner. Includes filter box with "spliner lock" system, one filter pad, one bag of bio-blox media and one 1 ¼ PVC male adapter. For ponds up to 1000 gallons.

- 22"Lx17"Wx14"H
- With Lid \$209.99
- Without Lid \$159.99
- Replacement filter pad \$13.99

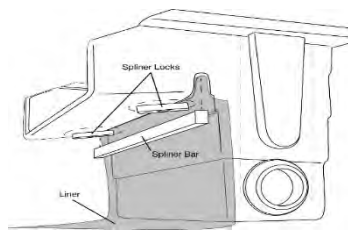

Atlantic Water Garden Polyethylene Biofilter BF1600

Sturdy top grate and support bar to allow natural rock camouflage. Dual bio-tech filter mats and media bag for biological filtration. Sturdy bottom grate supports filter medial. Rolled upper rim provides clean lines and incredible strength. One-piece liner attachment flange.

Model	Spill Width	Bulkhead	Max Pond Size	Max Flow	Price
BF1600	16"	1 ½"	1500 gallons	3000 GPH	\$374.99

Replacement Media Bag \$13.99 Replacement Filter Mat \$35.99



Elite Waterfalls

Elite Series Waterfall Filters are absolutely the strongest, most durable waterfalls on the market! They come standard with Matala Biological Filtration Mats and include a Landscape Lid for concealing the unit within the landscape. The octagonal design provides maximum strength, and a much easier shape to camouflage than circular or rectangle designs. With 2 bulkhead openings, pipes can be installed from either side. The second opening can be used as a back flush to perform water changes or connect multiple pumps or plumbing lines. The two included Matala mats have two times the biological benefit and will last up to four times longer than traditional mats. These boxes come with self-tapping stainless steel screws for easy installation and corrosion resistance. Lastly, the waterfall snout is reversible. Install in the usual way for basic installation or reverse the snout for a more advanced waterfall appearance.



Model	Inlet Size	Size LxWxH	For Ponds Up To	Waterfall Width	Max Flow	Filter Price
Small 14"	2 - 2"	23"x24.75"x21.75"	1500 gallons	14"	3500 GPH	\$439.99
Large 30"	2 - 3"	31.75"x40.5"x25.75"	6000 gallons	30"	10,000 GPH	\$849.99

Snorkel & Centipede Wetland Filter

Aquascapes patented Snorkel Vault and Centipede Module were specifically designed to tackle any number of the common issues that plague large scale water features. They are modular in design, allowing builders and designers the flexibility to expand the system to meet their needs. Highly effective at removing sediment (suspended solids) from the pond.

- Improves water clarity.
- Easily access collected sediment with the Snorkel Vault, reducing the need for costly and invasive dredging
- Works on earth bottom and liner membrane ponds
- Strips excess nutrients from the water column, reducing algae and the physical and chemical maintenance that goes along with removing algae
- Easily retrofitted onto existing ponds
- Create a waterfall and stream by designing the wetland filter system off the perimeter of the pond

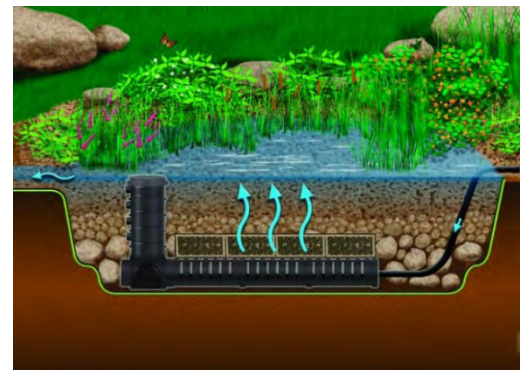
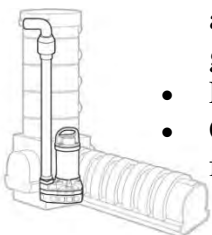

Snorkel \$669.99 Centipede \$439.99

Skimmers

Easy Pro Skimmer

Add a professional touch to any pond installation by providing an ideal place to hide the pump from view. A flange above the opening allows you to not only stack rocks along side the opening but also above the skimmer opening as well. Debris net and matala pad make cleaning easy.

Model	Weir Width	Size L x W x H	Pond Size	Max Pump Size	Price
Mini	6"	20"x15"x19"	250 sq. ft.	3000 GPH	\$369.99
Small	8"	28"x18"x20"	600 sq. ft.	6000 GPH	\$549.99
Large	16"	42"x20"x30"	600 sq. ft.	18,000 GPH	\$959.99



Extension Tube Mini/Small Skimmer \$109.99 Large Skimmer \$139.99
Weir & Faceplate 8" \$69.99



	Mini	Small	Large	Axiom
Debris Net	\$53.99	\$59.99	\$89.99	66.99
15" Brush each	\$9.99	\$9.99		\$9.99
Lid	\$57.99	\$119.99	\$169.99	
Matala Pad	\$19.99	\$29.99	\$39.99	



Axiom Skimmer

Features include front to back design – with the pump sitting behind the Debris net instead of alongside it. Adjustable overflow allows finished pond level to be adjusted. PSA7000 comes with dual 2" factory install spinweld fittings allowing for one or two pump installations. PSA9000 and PSA11000 come with two 2" and one 3" factory installed spinwelds.

Model	Weir Width	Size L x W x H	Recommended Flow Rate	Max Pump Size	Price
PSA7000	8"	29"x19"x21"	4500-6300 GPH	7000 GPH	\$489.99
PSA9000	8"	33"x19"x23"	6000-8100 GPH	9000 GPH	\$609.99
PSA11000	10"	33"x19"x23"	9100-9900 GPH	11000 GPH	\$609.99



Extension for 7000/9000 \$109.99

Skimmer for External Pump

Factory installed bulkhead fittings pre-plumbed for bottom drain connection. 8" weir inlet. Max flow 4500 gph. 20"x15"x 19" \$349.99

Skimmers provide excellent pre-filtering capabilities as well as a way to keep the pump mechanics out of sight. We can help design a filter and skimmer system for you that has the best combination of mechanical and biological filtration for the size pond and pump you have.



Axiom Pond Skimmer/Filter Combo

Combines mechanical and biological filtration in one. Includes debris net and filter brushes for mechanical filtration. A second compartment behind mechanical filtration holds biological media for complete water filtration.

3600 GPH Maximum flow rate. 8" Weir Width, 33"x19"x23" \$649.99

Aquascape Signature 400 Skimmer

Natural looking faux-rock lid to conceal in landscape. Rigid debris basket and filter mat for easy maintenance. Injection molded fittings for watertight seals. Rounded shape provides maximum strength. For ponds up to 400 sq. ft.

4000 GPH Maximum flow rate, 6" Weir Width.

21.5"x18"x21" \$629.99



Elite Skimmer

If reducing maintenance and protecting the life of your pond pump are important to you, then investing in a Pond Skimmer is key. The pond pump (sold separately), which is located inside the skimmer, draws water into the skimmer opening mechanically filtering out leaves, twigs and other floating garden pond debris trapping the debris inside a net and filter pad. Elite skimmers include matala filter mat and stainless steel frame as well as faux lid.



Model	Weir Width	Size L x W x H	Recommended Flow Rate	Max Pump Size	Max Pond	Price
Small	8"	26.25"x15.25"x19.75"	2500-3500 GPH	5000 GPH	11' x 16' or similar	\$449.99
Medium	10"	28.25"x19.25"x23.75"	5000-7500 GPH	10,000 GPH	21' x 26' or similar	\$649.99

Prelude In Pond Skimmer

Installs inside the liner and requires no tools, no cutting the liner and therefore no leaks. Comes with debris basket, filter pad and lid. Max flow rate 1800 gpm, ideal of mag drive pumps.

18"x15"x13", 5" water inlet \$159.99



Pondmax In Pond Skimmer

Easily connects to a variety of pumps with stepped hosetail fittings 1"/1.25"/1.5". Telescoping design adjusts to different depths 22"-36". Great for retrofit applications and large receptacle base for weighting down. Minimum flow rate 1500 gph, Maximum flow rate 4000 gph \$129.99



Auto-Fill Valves

Maintain a consistent pond level by installing an auto-fill in the skimmer. Can be hooked into existing irrigation.

- Brass Economy \$63.99
- Box Style \$46.99
- Atlantic Auto Fill \$42.99
- Easy Pro 1" \$134.99
- Aquascape Hudson Valve \$79.99

Pond Free Systems

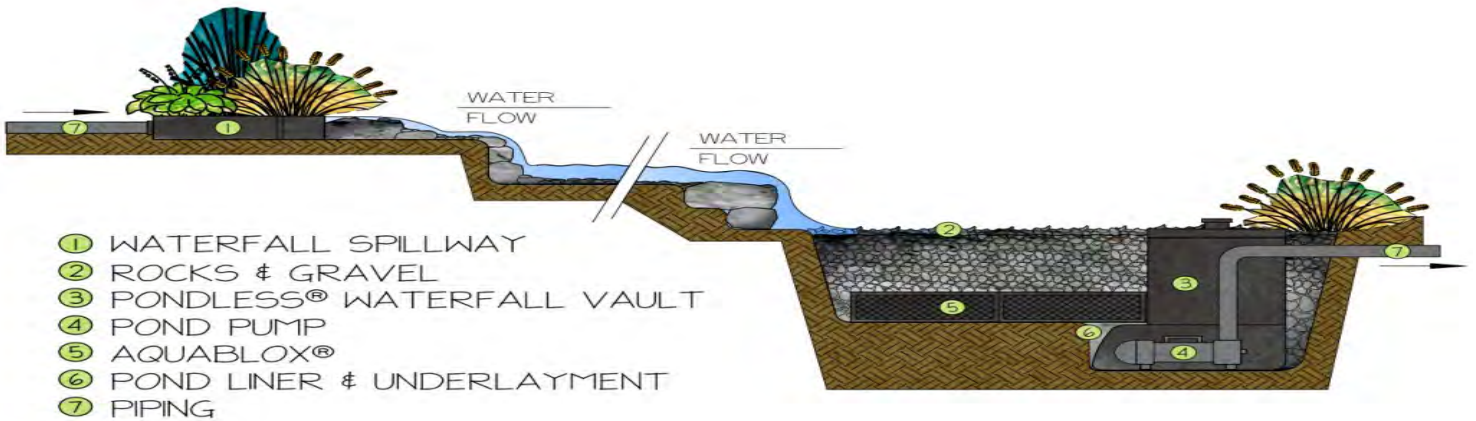

Aquascape Pondless Vault

Simple to install and maintain. Large interior fits a wide range of pump sizes up to 12,500 GPH. Excellent water circulation through horizontal and vertical water intakes. Easy to camouflage with built in water level inspection port.

23"x17"x 25.5" \$449.99

Extension \$139.99



Easy Pro Pump Vault

Roto-molded for excellent strength. Ideal for mag drive pumps.

Mini 13" diameter x 14.5" height, max flow 3000 GPH \$109.99



Easy Pro Pro Series Vault

Built heavy duty to withstand the pressure of being buried under rock. The slots cut in the sides allow water into the pump. 16"x16"x22" maximum flow is 7500 GPH

\$229.99 Extension \$104.99

Canyon Matrix

All in one houses and protects the pump while maximizing water volume. Perfect for Pond free systems. Basin 26.5" L x 16" W x 11.5" tall (13" with lid on) . Pump access hole 11.25" diameter. Max pump 2500 gph. Provides 21 gallons of water storage. \$219.99



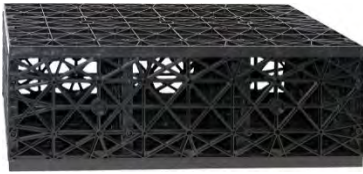

Reservoir Cube High Strength

Reservoir for pondless can be made smaller and fewer rocks used when using Res Cubes. Ideal for high weight bearing features and large boulders. Also great for under roadways, sidewalks and pathways. Can be used for water retention and recycling rain water. Quick assembly on site saves on space when shipping.

Small (1/2) 27"x16"x9.5" 17 gallons \$43.99 Large 27"x16"x17.5" 31 gallons \$67.99

Calculating Reservoir Size & Cubes

Calculate water volume in stream – L'xW"x.25x7.48
 Reservoir should be at least 2x the volume in stream
 Gallons in Reservoir divided by gallons in cube = number of cubes.
 Reservoir should be dug to fit number of cubes and vault.

Stream 12' long and 2" wide = 45 gallons
 Reservoir = at least 90 gallons
 Small (1/2) Reservoir Cube = 17 gallons
 90 divided by 17 = 6 Small 1/2 Cubes

Lay out cubes (stacked 2 high) and vault to determine size of reservoir (approximately 5'x3'x2' deep)



Pond Free Waterfall Weir

Pondmaster Proline Waterfall Box

Create a waterfall or stream in tight spaces using the waterfall box. Easy to conceal by burying it into the ground. You supply media for biological filtration.

Pro1000 12"Lx9"Wx7"H 8" opening \$59.99
 Pro2000 15"Lx12"wx9"H 11 1/4" opening \$69.99



Aquascape Waterfall Spillway

Durable design makes it easy to disguise by allowing soil, rocks or logs to be placed directly on top of the unit. Comes complete with a 2" PVC slip fitting, 1 1/2" barbed hose fitting and pre-installed bulkhead.

22" wide spillway handles flow rate up to 7500 GPH. \$249.99
 12" wide spillway handles flow rate up to 4000 GPH \$249.99



Easy Pro Waterfall Diffuser

Fast and easy way to create professional looking waterfalls. Ideal for use at beginning of streams and in block walls, pools and formal fountains. Super strong vertical rib design creates a nearly indestructible diffuser. Can be used in multiples for wider applications. Dual 2" inlets.

23" wide x 14" deep x 3.5" tall 1500-6000 gph \$154.99
 16" wide x 14" deep x 3.5" tall 1000-4000 gph \$119.99



Country Gardens
(978)948-2124

Cascade Box 10"

Waterfall width 10" Spillway. Inlet Size: (2) 1" Spinweld. Includes landscape lid attached. 8.5" x 10" x 8" . Max. Pump Flow 1800 gph \$89.99



Corner Falls

Fits tightly into any corner install inside liner or with liner attached to front. Waterfall width 12". Dual inlets size 1.5". Max flow rater 2500 gph 12"x12"x10"h \$179.99

Vianti Falls Stainless Steel Spillway

This spillway has a 6" lip. Internal baffle calm incoming water – creating an even and smooth flow over the lip. 1" fpt connections. Ideal for formal features, signs and swimming pool features.

23" wide – recommended flow rate 1200 gph - \$449.99

35" wide – recommended flow rate 1800 gph - \$549.99

Custom sizes available from 11.5" -71.5" wide.

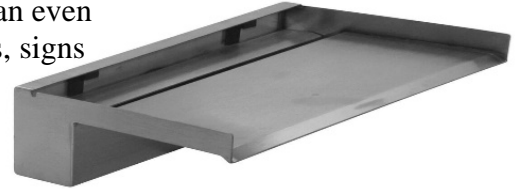

CabrioColor Light Strip 23" for Vianti Spillway

Compatible with Viante Falls 23" spillway. Wide spectrum of color options.

15' power cord with quick connect fittings.

1 year warranty. Includes remote \$219.99

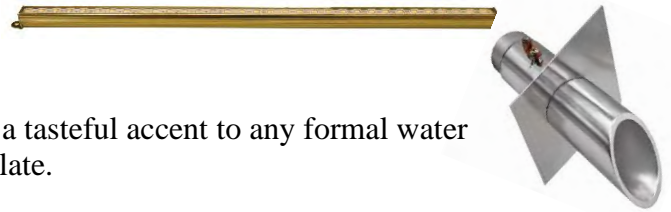

Viante Wall Scupper

Stainless Steel. A classic stand-alon water feature or use as a tasteful accent to any formal water feature. 2" diameter by 8" long. 4.5" x 6.5" diamond trim plate.

5-10 gph recommended flow rate. 1" fpt inlet. \$189.99



Spillway Basin

Basin has a pre-filter pump chamber and built in plumbing channels. Anti-splash mat installs on top of basin to virtually eliminate splash and reduce water loss. Cover the mat around the waterfall with gravel for a more natural look.



	Basin	Splash Mat
24"	\$471.99	\$69.99
36"	\$536.99	\$92.99



Stainless Steel Splash Ring

Keep stones in place and splash at bay with style. Set the mesh panel facing up to sow off the broad trim ring or flip the Splash Ring over to keep stones in place almost invisibly. Placing an LED light under the mesh to illuminate the falls from below while hiding the light from direct view adds nocturnal charm.

24" \$389.99 36" \$499.99

Ultra Violet Light

Evo UV

The Evolution Aqua evoUV delivers a more efficient and economical performance than before. The range includes a completely redesigned 15 Watt, 30 Watt and 110 Watt model that are perfect for use on a variety of garden ponds. The evoUVs are designed to clear and mitigate green water which is typically caused by single celled green algae. The evoUVs are compatible with various filtration systems but when paired alongside Evolution Aqua's pond filtration systems, the evoUV will deliver crystal clear and healthy pond water.

- Eradicates green water in garden ponds
- Features highly efficient ballasts
- IP Rating of IPX5
- Easy to maintain, easy to install
- Ballast located in a fully water-tight cover
- Connects to flexi-hose or rigid pipework



Model	Max pond Size	Max Flow Rate	Bulb Power	Inlet/Outlet	Fittings Supplied	Dimensions	Price
EVO15	2000 gallons	2000 gph	15 watt 1x15w T8	1 1/2"	2 x 1 1/2" Threaded Hosetails	23" long 7" wide	\$319.99
EVO30	3800 gallons	4000 gph	30 watt 1x30w T8	1 1/2"	2 x 1 1/2" Threaded Hosetails	39" long 7" wide	\$469.99
EVO110	9750 gallons	6000 gph	110 watt 2x55w T8	2"	No fittings	41" long 12" wide	\$1059.99

Replacement Parts

	T8 Bulbs	Quartz Sleeve	O'Ring	Ballast Box
15 watt	\$39.99	\$49.99	\$12.99	\$209.99
30 watt	\$64.99	\$59.99	\$12.99	\$209.99
55 watt	\$79.99	\$59.99	\$15.99	\$249.99



Evo UV Union 1.5" \$39.99



Aqua Ultra Violet UV Advantage UV



The Advantage Series is ideal for small ponds, aquariums, and water features. Advantage UV's are slim, lightweight units designed for maximum UV effectiveness. Aqua Ultraviolet UV's will clear your water in 3 to 5 days sometimes overnight and keep it that way. Performance is guaranteed when sized, installed and operated according to our instructions. 3/4" barbed inlet

and outlet. 15 watt for ponds up to 500 gallons, max flow 700 gph \$334.99

Replacement Bulb \$92.99

Replacement Quartz Sleeve \$86.99

Replacement Transformer \$196.99

Teton Professional UV Clarifier

Offers multi-directional 2” outlet for ease of plumbing. The 16 watt model is aluminum housing while the larger are stainless steel. These metal housing have a more reflective capacity for the UVC and are durable. 2 year warranty on the ballast and a 5 year warranty on the housing.

Model	Max Flow	Pond Volume	Inlet Outlet	Price	Replacement Bulb
16 watt	2000 gph	4000 gallons	2”	\$399.99	\$49.99
25 watt	2750 gph	5500 gallons	2”	\$499.99	\$69.99
40 watt	3750 gph	7500 gallons	2”	\$599.99	\$99.99
80 watt	5000 gph	10,000 gallons	2”	\$749.99	\$149.99
120 watt	7000 gph	14,000 gallons	2”	\$1099.99	\$209.99

Replacement UV Parts

Smart UV Models

Model	UV Lamp	Quartz Sleeve	Power Supply
18 watt	\$93.99	\$54.99	\$169.99
25 watt	\$95.99	\$64.99	\$169.99
40 watt	\$99.99	\$89.99	\$169.99
80 watt HO	\$109.99	\$89.99	\$219.99



4 pin connector with starter bulb \$24.99 without bulb \$10.99
 Service Kit \$39.99



In order for a UV to work properly it must be sized not only to the pond size but also the flow rate of the pump. Stagnant areas within the pond will also impact how well the UV clears green water. Does not kill string algae.

UV Bulbs should be replaced annually. If the unit is oversized for the pond you may get a longer bulb life. A good indication that the bulb needs replacing is that the water is turning green. An older bulb may still light, but not have the necessary UV to kill alae. A bulb that does not light usually indicates a power problem rather than an old bulb.

Under Water Lights

PondMax Pond and Garden Lighting

Safe, Simple and Cost-Effective. LED lights in either warm white or color-changing. 2 sizes offer versatile connectivity and numerous mounting options. Rated for underwater and outdoor use. Can be daisy chained for easy connections.

White Only Light

3 Light Complete Kit – includes 1 starter light, 2 add-on lights, transformer and photocell. 2 additional add on lights can be purchased to be used with kit.

Large \$304.99 Replacement Bulb \$32.99
Small \$254.99 \$26.99

Add On Light

Includes light fixture, weighted base, garden stake, 9' of cable.
(cannot be used without starter light and transformer)

Large \$79.99
Small \$69.99

Single Starter Light

Includes fixture, weighted base, garden stake, 16' of cable, 3' transformer adapter cable.
(needs transformer sold separately)

Large \$89.99
Small \$79.99

Color Changing Light

3 Light Complete Kit – includes 1 starter light, 2 add-on lights, remote and receiver to change colors, transformer and photocell. 2 additional add on lights can be purchased to be used with kit.

Large \$464.99 Replacement Bulb \$69.99
Small \$334.99 \$29.99

Add On Light

Includes light fixture, weighted base, garden stake, 9' of cable.
(cannot be used without starter light and transformer)

Large \$99.99
Small \$64.99

Single Starter Light

Includes fixture, weighted base, garden stake, 16' of cable, 3' transformer adapter cable, remote and receiver to change colors. (needs transformer sold separately)

Large \$214.99
Small \$174.99

Fountain & Waterfall Light Kit

3 LED lights 2.8 watts each with 18 watt transformer included.
First light is 16' from transformer then lights are daisy changed together with 5' between each light. \$159.99
Add on light for Light Kit \$69.99



Consider your night-time pond viewing. Most of us work all day and could benefit from the relaxing sound of the waterfall in the evening. Illuminating the water with underwater lighting enables you to enjoy your fish anytime. You can choose a soft clear light or a variety of colored lenses can change the atmosphere. These are low voltage lights which sometimes can be tied into existing low voltage garden lights or used on their own.

****The one of the best areas to place lights is under the waterfall****

Accessories

- 24 watt Transformer \$54.99
- 36 watt Transformer \$59.99
- Photocell (ON at dusk, OFF at dawn) Handles up to 100 watts. \$39.99
- Photocell with Timer \$49.99
- 16' Extension Cable. Handles up to 100 watts \$43.99
 - 2 pin for white LED lights
 - 4 pin for color changing LED lights
- 3 way Splitter \$14.99
- 5 way Splitter for white \$18.99 for color \$64.99
- Color Controller \$129.99
- Remote for Color Controller \$24.99



LED Ring/Statuary Lights

Barbed inlet fitting for use with 3/4" tubing. 10' power cord between light and transformer, 6' power cord on transformer. Light ring is 1 3/8" diameter with center hole for water to pass through. Single \$43.99 Triple \$89.99

LED Color Changing Lights

All-in-one kit developed to provide an impressive accent to fountains, connecting easily to the top of the fountain with an integrated barbed fitting. Wide variety of color options, and the integrated white diodes provide a true, warm white light when desired. These low-voltage lights are extremely energy-efficient and include professional, weatherproof quick-connect fittings for quick and easy installation. The kit includes one fountain light, a 12-volt transformer, and a wireless remote used to control the light settings. \$121.99



Aquascape LED Accessories

- 6 watt Transformer \$39.99
- 3 way splitter \$16.99
- 25' Extension Cable \$26.99
- Photocell \$40.99



Aquascape Smart Control Plug

Allows you to control and monitor outdoor electronics from your anywhere using your Smart phone or Tablet. The plug features three outlets so you can control three products simultaneously. Use dynamic scheduling to have products turn on automatically when you need them and get real-time energy consumption data for any electronic device. The device also works with Alexa for easy voice control. Adequate wireless coverage is required (2.4 GHz supported). 3-year limited warranty \$69.99

Disappearing Fountains

Create a low maintenance water feature with a disappearing basin. These reservoirs are made of high density polyethylene. Any statuary or pottery that can be plumbed can be used as the focal point of your fountain.

Atlantic Fountain Basin

One piece construction provides exceptional strength. Built-in channels simplify installation, allowing the plumbing to be run on top of the basin. Molded cones support the top panel. 1 1/2" conduit recessed allow for clean installation in surrounding masonry without noticing. Flat panel for optional Auto Fill installation.

<u>Model</u>	<u>Max Pump</u>	<u>Plumbing Size</u>	<u>Capacity</u>	<u>Supports Up To</u>	<u>Price</u>
FB2400	750 gph	up to 1/2"	20 gallons	200 lbs.	\$225.99
FB3500	2000 gph	(3) 3/4" or (1) 1"	32 gallons	400 lbs	\$506.99
FB4700	4000 gph	up to 1 1/2"	75 gallons	1200 lbs	\$771.99



Eco Rise

Strong radial structure handles the weight of heavier statuary, vases and columns while providing a broad stable base over pondless reservoirs. Keeps plumbing and flow adjustments topside for easy access.

20"x20"x3" Max load 3,000 lbs.

\$126.99

\$31.99 – 12" EcoRise

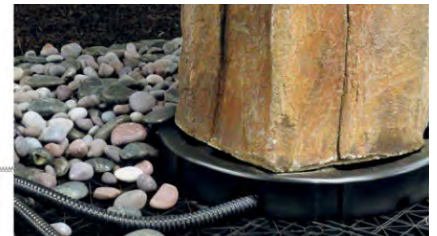
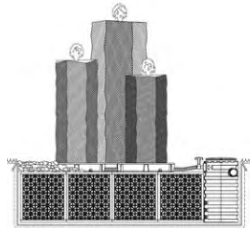









Aquabasin 45

The basin is constructed of professional-grade, high-density polyethylene. Handles pump flow rates up 4,000 gallons per hour and can store up to 98 gallons of water. Drillable deck cylinders across the top of the basin provide endless plumbing and lighting options and keep unsightly cables and plumbing out of sight. The large, flat deck makes it easy to set and position fountains and the center cylinder is pre-drilled for plumbing single fountain applications. A pump access panel with integrated handle makes it easy to remove the cover for pump access. The large size of the corner access is compatible with larger pumps and is the area is elevated to prevent gravel from falling into the basin during pump maintenance. \$749.99



Brass Fountains

	Round Aura 24"	Round Aura 24" with spill	Round Aura 32"	Square Urn 30"	Square Urn 36"	Square Urn 42"
						
Recommended Pump	750 gph	750 gph	1250 gph	800 gph	800 gph	800 gph
Recommended Basin	FB3500	FB3500	FB4700	FB4700	FB4700	FB4700
Fountain Only	\$1080.99	\$995.99	\$1473.99	\$1799.99	\$2279.99	\$2879.99
Fountain Kit	\$1782.99	\$1697.99	\$2588.99	\$2806.99	\$3268.99	\$3878.99
Triple Square Urn Kit \$6999.99						

	Spillway Bowl 18"	Spillway Bowl 24"	Spillway Bowl 28"
			
Recommended Pump	1250 gph	1250 gph	1250 gph
Recommended Basin	FB4700	FB4700	FB4700
Fountain Only	\$1079.99	\$1159.99	\$1199.99
Fountain Kit	\$2198.99	\$2278.99	\$2318.99
Triple Bowl Kit \$4999.99			



Smooth Vase Terra

Deco Crete material provides the look and durability of traditional concrete without the cumbersome weight. Made with alternative concrete material that is fiber reinforced for strength. Includes 3' of tubing.
19"x19" x 21" tall. \$159.99

Aged Tipped Copper Vase



Deco-crete garden art that can be enjoyed for years. Deep cavity and large inlet tubing allow for higher flow up to 1000 gph. Includes 3' of ¾" tubing.
14" long x 20" wide x 17" tall
Vase Only \$129.99

	Smooth Vase Terra	Aged Tipped Copper Vase
Recommended Pump	290 gph	530 gph
Recommended Basin	FB2400	FB2400
Vase Only Price	\$159.99	\$129.99
Complete Kit Price	\$822.99	\$590.99



Bamboo Basalt Fountain

Taller basalt is core drilled with 1.25" hole at the bottom and connects to side hole for bamboo attachment. Water cascades from bamboo spout to lower basalt stone which overflows into basin below.

39" pillar basalt approx. 8"-10" diameter

8"-10" tall lower stone approx. 12"-15" diameter

\$899.99 2 piece basalt only (weight approx. 320 lbs)

\$1811.99 complete kit includes FB4700 basin & 290 gph pump



Bevel Sided Basalt 16"

Polished on 2 sides with smooth polished top. 14-16" average diameter. Column is core drilled with a 1.25" hole from end to end the last 1.5" is enlarged to hide light ring. Size and weight will vary due to natural characteristics

\$449.99 basalt only

\$1176.99 complete kit includes FB3500 basin & 660 gph pump



Basalt Rock Columns (Polished Top)

Natural cut sides with polished ends make for a beautiful display even if the pump is off. Each column is core drilled with a 1 1/4" hole from end to end.

The last 1 1/2" is enlarged to 1 3/8" to hide light ring (sold separately).

Trio weight approx. 350 lbs

	20" Basalt	27" Basalt	35" Basalt	Trio 20/27/35
Recommended Pump	290 gph	290 gph	370 gph	TT2000 gph
Recommended Basin	FB3500	FB3500	FB4700	FB4700
<i>Rock Only</i>	<i>\$349.99</i>	<i>\$439.99</i>	<i>\$529.99</i>	<i>\$1299.99</i>
<i>Complete Kit</i>	<i>\$976.99</i>	<i>\$1116.99</i>	<i>\$1505.99</i>	<i>\$2499.99</i>

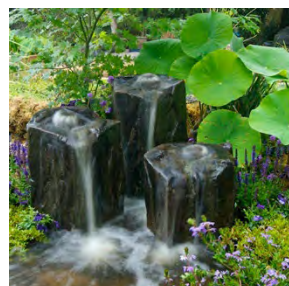

Column Fountain Rocks

GFCR (glass fiber reinforced concrete) fountains that fall with expression. With the natural beauty of real rocks, but with more durability and less weight. Weigh a fraction of what real boulders would weigh and are specifically designed to make an eye catching water feature. Large center hole takes 1.5" flex hose. Use singularly or as a triple fountain.

	18" Tall Rock 16"x18"x18" 30 lbs	24" Tall Rock 16"x18"x24" 45 lbs	28" Tall Rock 16"x18"x28" 55 lbs	Trio 18/24/28
Recommended Pump	800 gph	800 gph	800 gph	TT3000 gph
Recommended Basin	FB4700	FB4700	FB4700	10 Res Cubes & 10x10 liner
<i>Rock Only</i>	<i>\$439.99</i>	<i>\$479.99</i>	<i>\$549.99</i>	<i>\$1469.99</i>
<i>Complete Kit</i>	<i>\$1431.99</i>	<i>\$1473.99</i>	<i>\$1546.99</i>	<i>\$2699.99</i>

Eternal Springs Rock Collection

Quality light weight concrete bubbler rocks offering exceptional realism, simple installation and easy maintenance. Constructed from Glass Fiber Reinforced Concrete.



Triple Cascade \$479.99
32"x18"x24" 60 lbs



Agate Falls \$239.99
18"x19"x13" 44 lbs



Klamath \$399.99
18"x19"x16" 42 lbs



Sonoma \$419.99
12"x17"x24" 50 lbs



Alder Falls \$329.99
20"x22"x16" 50 lbs



Sand River Falls \$479.99
28"x24"x17" 86 lbs

Agawa Falls \$199.99
17"x14"x9"



	Agawa	Agate	Alder	Sonoma	Klamath	Sand River	Triple Cascade
Recommended Pump	290 gph	370 gph	660 gph	660 gph	660 gph	800 gph	1110 gph
Recommended Basin	FB2400	FB3500	FB3500	FB3500	FB3500	FB4700	FB4700
Rock Only	\$199.99	\$239.99	\$329.99	\$419.99	\$399.99	\$459.99	\$479.99
Complete Kit	\$547.99	\$949.99	\$1018.99	\$1122.99	\$1103.99	\$1591.99	\$1563.99



Faux Basalt Columns

Three columns measuring 24 inches, 30 inches, and 36 inches in height. Each column is molded from real basalts and handmade in the USA using fiberglass, resin, and real stone to provide an extremely realistic and durable fountain. Real basalt is extremely heavy and can be difficult to install. Due to the lightweight nature of the faux basalts, installation is quick and easy. Each column provides a convenient base, making it easy to secure in place using decorative gravel.

	24" Tall Rock	30" Tall Rock	36" Tall Rock	Trio 24/30/36
Recommended Pump	550 gph	800 gph	800 gph	TT3000 gph
Recommended Basin	FB3500	FB4700	FB4700	10 Res Cubes & 10x10 Liner
<i>Rock Only</i>	\$479.99	\$539.99	\$649.99	\$1659.99
<i>Complete Kit</i>	\$1174.99	\$1510.99	\$1645.99	\$2799.99

Spillway Bowl/Basin

Create a beautiful spilling water feature in a variety of installation possibilities. Either can be installed as a standalone disappearing water feature or installed into an existing pond or water feature. Combine the Spillway Bowl with the Spillway Basin, Spillway Bowl Stand, and water basin for an incredible standalone feature that is sure to impress. Made from durable GFRC, this incredible decorative feature is easy to install and built for years of trouble-free enjoyment. Its unique patina finish allows the blend to blend naturally into any environment. The included standpipe provides multiple options for tweaking the water flow after installation.



	Small Spillway Bowl	Small Basin	Small Stand	Medium Spillway Bowl	Medium Basin	Medium Stand
Size	19" diameter	21" diameter	6" tall	32" diameter 14.5" tall	40" diameter 16" tall	13.5" wide 4" tall
Recommended Pump	800 gph			2000 gph		
Recommended Basin	FB3500			FB4700		
<i>Price Bowl Only</i>	\$219.99	\$249.99	\$89.99	\$559.99	\$799.99	\$159.99 <i>2 pack</i>
<i>Price Complete Kit</i>	\$1299.99			\$2699.99		



Twister Mini Fountain Kit

Includes basin, pump, plumbing, and color light kit. (pebbles sold separately)
fountain 12"x12" basin 16"x16"x16"
\$599.99



Urns, Sphere & Wall

Made from lightweight, durable fiberglass-resin composite providing the look and beauty of real stacked slate stone. These unique water features are extremely versatile for use in a wide variety of applications, including standalone fountains, pond edges, or the start of waterfalls and streams.



Stacked Slate Urn

	Mini	X-Small	Small	Medium	Large
Size	13" tall	21.25" diameter 24" tall	21.25" diameter 33.5" tall	27" diameter 45" tall	35.5" diameter 55" tall
Recommended Pump	290 gph	550 gph	550 gph	1250 gph	
Recommended Basin	FB2400	FB3500	FB4700	FB4700	Custom Liner & Cubes
Price Urn Only	\$119.99	\$339.99	\$629.99	\$1099.99	\$1799.99
Complete Kit	\$549.99	\$1013.99	\$1593.99	\$2315.99	Call for pricing

Stacked Slate Sphere

	X-Small	Small	Medium	Large
Size	18" diameter 16" tall	24" diameter 22" tall	32" diameter 30" tall	40" diameter 37.5" tall
Recommended Pump	550 gph	800 gph	1500 gph	2000 gph
Recommended Basin	FB3500	FB4700	FB4700	Custom Liner & Cubes
Price Sphere Only	\$339.99	\$629.99	\$1099.99	\$1799.99
Complete Kit	\$1014.99	\$1620.99	\$2244.99	Call for pricing



Scalloped Urn



	Small	Medium	Large
Size	20" diameter 32" tall	27" diameter 45" tall	38" diameter 56" tall
Recommended Pump	550 gph	1250 gph	2000 gph
Recommended Basin	FB4700	FB4700	Custom Liner & Cubes
Price Vase Only	\$629.99	\$1099.99	\$1799.99
Complete Kit	\$1593.99	\$2315.99	Call for pricing

Stacked Slate Spillway Wall

36" long x 12" wide x 32" tall

Recommended Pump 2000 gph or larger pump.

Recommended Basin FB4700

\$919.99 Available in curved or straight wall

\$1999.99 Complete Kit with FB4700 basin and TT2000 pump



The Balanced Pond

The lure of the pond is, of course, its fish and aquatic plants. In creating a water garden you are establishing a miniature ecosystem, balance is essential. Planting the pool precedes the stocking with fish. Plants will balance a pool by oxygenating it (they absorb carbon-dioxide and exude oxygen, while fish do the opposite) and by shading it from excessive sunlight. Too much sunlight encourages the rapid growth of algae.

Typically, the balancing will follow this course. New water will be clear, but once sunlight has penetrated it a green algae will form. This is a natural reaction due to the many nutrients in the water. Aquatic plants compete with algae for these nutrients and they will eventually win over if they are stocked in the proper ratio. Be sure to use floating plants or water lilies to cut out the amount of sunlight in the water. Because your water garden is a closed miniature ecosystem, a filter helps to provide a breeding bed for nitrifying bacteria used in the pond's nitrogen cycle. Seeding the filter with bacteria will give a jump start in the spring after a cold winter to speed the balancing process.

Plants themselves should be introduced to the pond during the growing season. To achieve the correct biological balance in your aquatic ecosystem, you should have a collection of the following:

*Oxygenators: Essential for maintaining water clarity. They also help to benefit fish as they absorb sunlight and emit oxygen. One bunch for every two square feet or 1 bag per 5 square feet.

*Deep Water Plants: Decorative, colorful blooms such as the well-known lily. Available in many shades of white, pink, red, and yellow.

*Marginals: Planted in shallower water, these help to break up the formal edges of a pool, giving a more natural appearance. Many varieties of contrasting color and foliage.

*Floating Plants: These help control blanket weed and green water by minimizing the amount of sunlight on the water surface.

Although there is much variation in pool planting, we recommend the following guidelines when planting the pond:

- ❖ Cover at 50-70% of the surface area with floating plants and lilies during the summer months to block sunlight and deter algae growth
- ❖ Submerged plants can be put out early in the pond and can provide hiding places for small fish
- ❖ Marginal plants provided different textures, colors, and heights for a visually pleasing pond
- ❖ Plants will need to be transplanted and thinned out as the pond matures.

Start with the following stocking formulas and adjusted to your pond plant preferences:

For small pools up to 300 gallons:

1-3 bag oxygenators, 2 marginals, 3 floating plants

For medium pools 300-1000 gallons:

3-8 bags oxygenators, 4-8 marginals, 3-6 floating plants, 1-2 water lily

For large pools about 1000-2500 gallons:

10-16 bags oxygenators, 6-10 marginals, 6-12 floating plants, 1-3 water lily

For very large pools over 2500 gallons:

20 bags oxygenators, 12-18 marginals, 12-24 floating plants, 5-8 water lilies

**floating plant count refers to initial spring purchase*

Two to three weeks after planting, you may wish to introduce fish to your pond. There are many varieties of hardy pond fish that can be mixed safely together, including the exotic Koi Carp, the hardy Goldfish, the active Golden Orfe, the graceful Shubunkin, and the brilliant Comet Goldfish.

In general, the stocking ratio for a new pool should be 1" to 2" of fish for every square foot of water surface. Maintaining this level will ensure that conditions in the pool remain healthy. Further, the pool's total fish collection should be introduced gradually over a period of time so that the total ecosystem can adapt, taking into consideration the growth potential of the fish.

A large fish population is the other reason to include a biological filter in your pond. Fish waste can be toxic if not controlled by nitrifying bacteria. These bacteria help to take this toxic substance and convert it to nitrate, a plant nutrient.

When introducing the new fish to the pool, float the unopened bag on the pond surface for fifteen to twenty minutes, so that the temperature of the water inside the bag will adjust to that of the pond. You can also introduce several cups of the pond water into the bag to help minimize stress due to the changes in water chemistry. Once the water has adjusted, release the fish slowly into the pond. Their natural tendency to hide in the depths will quickly be overcome as the fish adapt to their new environment. Once acclimated, they will readily swim to the surface for feeding.

Finally, one of the most aesthetically pleasing ways to help keep both your fish and plants vibrant in clear, healthy water is the introduction of a fountain ornament or waterfall. Sculptures and waterfalls move water continuously for a cleansing and aerating effect which is essential to the survival of your eco-system. They blend beautifully as a graceful accent to any natural pond setting.

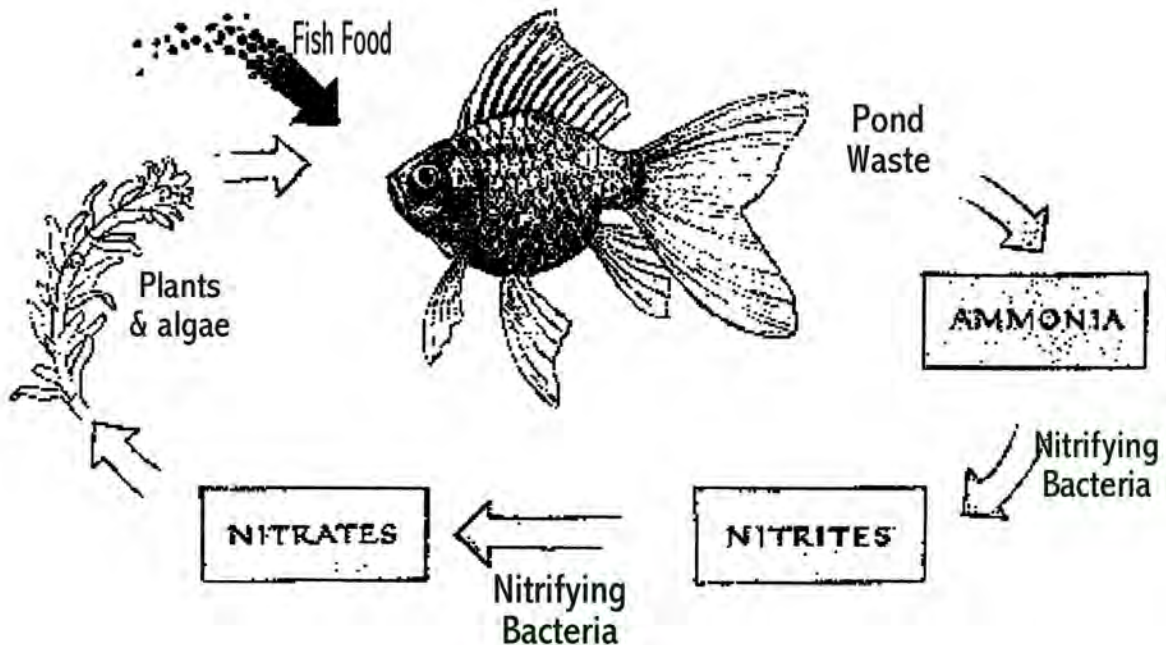

The Nitrogen Cycle

Water Lilies (Nymphaea)

Pads floating on the surface and colorful blooms of the water lily make it the most popular aquatic plant for water gardens. But they are not just a pretty addition - they provide shade and protection for the fish as well as consuming nutrients and sunlight loved by algae. The range of colors available are sure to complement any pond landscape.

For spectacular lilies the following guidelines should be taken:

- ✓ Minimum pot size of 10" should be used (16"-20" better)
- ✓ Prune and fertilize every 2-4 weeks throughout the season
- ✓ Depth of 12-24" over tuber is ideal
- ✓ 6 Hours of sunlight is ideal

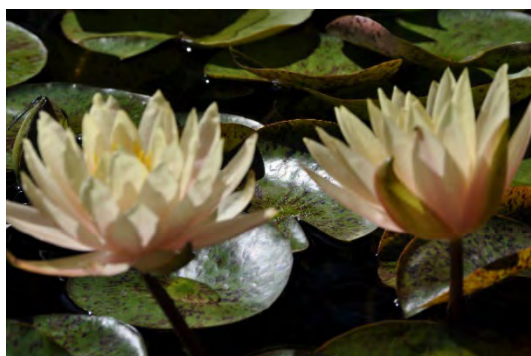

Hardy

Hardy water lilies are all perennial and will bloom year after year even in the coldest areas of this country. Generally, their blossoms float on the surface of the water, raising them up above only in very crowded conditions. All are day blooming with flowers that open late morning and close late afternoon repeatedly for 3 to 5 days. New blossoms should keep coming throughout the summer months. As fall approaches the hardy lily will show fewer and smaller pads eventually dying back for the winter. Containers should be placed in water below

ice line to keep plant tuber from freezing in winter. Blossoms can be yellow, pink to red shades, white or peach to orange shades. Repotting is usually necessary every 2-3 years



Tropical

Tropical lilies are best in ponds where daytime temperatures average 70 degrees or from May 25 - September 1. In addition to a wider variety of colors than a hardy lily, the blossoms of a tropical lily usually rise above the surface of the water and often multiple blossoms will open on one plant. The pads are larger with scalloped edges and some will have a purple mottling. In addition to the traditional day blooming lily, night-blooming tropical lilies open late afternoon and close early morning. They will bloom until the frost. Blooms in blues, purples, yellow, pink to red shades, white. Over-

wintering can be difficult in northern climates so we recommend discarding a tropical lily each fall.

Intersubgeneric!

Many hybridizers have been working on crossing a hardy lily with the tropical lilies to get the best characteristics of each in one lily! While still just a few varieties available, we now have a purple hardy water lily.

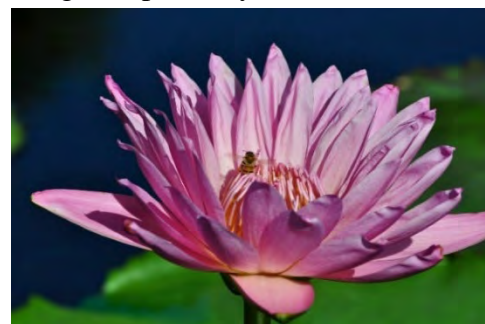

Lotus (Nelumbo)

Lotus take a year to become established. They send up aerial leaves and sometimes blossoms the first season. Blossoms begin in July, with the blooming season lasting 6 to 8 weeks. Blossoms open early in the morning and close in mid-afternoon. They need 5 to 6 hours of sunlight minimum and prefer still water that is 2 to 4 inches above the soil. Lotus require several weeks of sunny weather in the 80's in order to bloom. They do best if fed heavily and planted in large containers (except for smaller varieties).



Cross-Section of a Pond

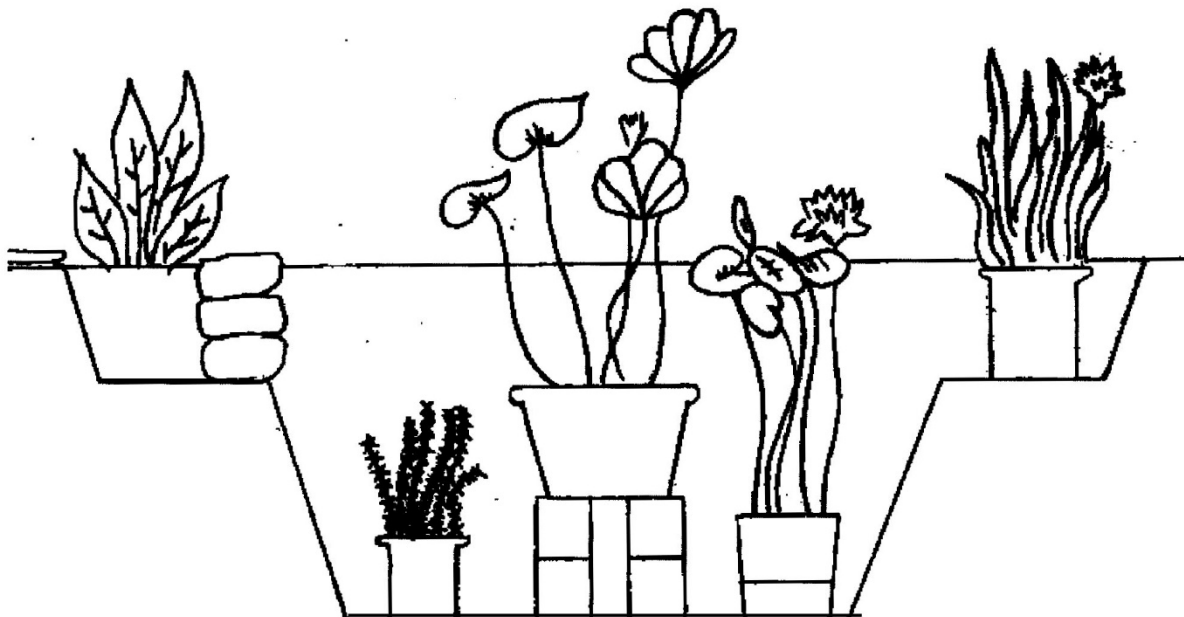

Hardy Marginal Plants

Arrow Arum – (Peltandra virginica) Narrow light green spathes. Dark green arrow-shaped leaves arising from short fleshy roots. Height to 24", depth 2-6"

Arrowhead, Giant - (Sagittaria latifolia) Given plenty of room this plant is most attractive with large, fleshy stems and arrow-shaped leaves. Produces stalks with classic white flowers. Tolerates some shade. Height 18-24 inches, depth 3-5 inches.

Bloody Dock (Rumex Sanguineus) Green leaves with deep red veins. Height 12-18", depth 0-2"

Bog Bean (Memyanthes trifoliata) Trailing green foliage with small white flowers. Height 6-12", depth 0-4"

Cardinal Flower - (Lobelia cardinalis) Gorgeous, slender plant with crimson flowering spikes. Height to 36", depth 0-2 inches.

Cattail, Dwarf - (Typha laxmannii) The perfect cattail for the smaller pond. Develops chubby 2 inch catkins in autumn once established. Height 24-30 inches, depth 0-4 inches.

Cattail, Graceful - (Typha angustifolia) Has narrow leaves. Height 5-6 feet, depth 0-6 inches.



Chameleon Plant (Houttoynia cordata variegata) Multi colored, heart shaped leaves of green white and maroon with small white flowers. Height 12-18", depth 0-2"

Clover Four Leaf – (Marsilea quadrifolia) Solid green leaves 2" in diameter with 4 lobes. Height 12", depth 0-2"

Dwarf Variegated Sweet Flag - (Acorus gramineus variegatus) Pleases even the most discerning. Stripes of green and white on

slender leaves highlights any pool border. Height 12 inches, depth 2-6 inches.

Houttoynia Cordata – (Houttoynia cordata) Dark green heart shaped foliage with small white flowers. Height 12-18", depth 0-2"

Iris - Many different varieties of water iris in colors such as blue, yellow, white, purple, and pink. Height 12-36 inches, depth 2-6 inches.

Lizard's Tail - (Saururus cernuus) Fragrant white flowers produced on long spikes. Somewhat heart shaped leaves. Height 12-18 inches, depth 0-6 inches.

Obedient Plant – (Physostegia leptophylla) Abundant lavender stalks of flowers. Free flowering. Height to 36", depth 2-6"

Pickeral, Blue- (Pontederia cordata) An excellent plant for any pond. Has glossy, green heart-shaped leaves and soft blue flowering spikes during mid-summer. Tolerates some shade. Height 18-36 inches, depth 1-7 inches.

Pickeral, White – (Pontederia cordata alba) Shiny, heart-shaped foliage. Large flowering spikes and long blooming season. Height to 36", depth 2-6".

Rush, Corkscrew - (Juncus effusus spiralis) Thin twisted corkscrew stems. Very unique. Height to 24 inches, depth 2-6 inches.

Rush Goldstrike – (Juncus effusus "Gold Strike") Striking foliage of dark green with yellowish gold vertical striping. Height to 12", depth 2-4".

Rush, Horsetail - (Equisetum hyemale) Dark green segmented stalks, similar to bamboo. Height to 36 inches, depth 2-6 inches.

Rush, Zebra - (Scirpus zebrinus) Vertical stems banded with white rings on the new stems. Ideal for background. Height 24-36 inches, depth 0-4 inches.

Water Celery Variegated - (Oenanthe javanica "Flamingo") Compact leaves similar to those found on celery stalks. Beautifully variegated with pink, white & green. Height to 8", depth 2-6".

Tropical Marginal Plants

Blue Bell - (Ruella squarrosa)

Small bluebell flowers on short green linear foliage. Height to 24 inches, depth 0-2 inches.

Creeping Primrose - (Jussiaea repens) These surface creepers bear striking, bright yellow flowers resembling buttercups up to 2 inches in diameter. Rapid growth and glossy green, oval leaves, 1 inch long, distinguish this plant, which may be invasive. Depth 2-12 inches.

Papyrus, Giant (Cyperus papyrus)

Also known as Egyptian Paper Plant. Tall dark green stems topped with many long, gracefully arching hairs. Grows in clumps. Height 48-60 inches, depth 0-4 inches.

Papyrus, Dwarf - (Cyperus haspans)

A mini version of the Papyrus topped with a short tufted ball which is finer and more compact than the standard. Height 24 inches, depth 0-2 inches.

Papyrus Dwarf Giant King Tut (Papyrus percamenthus) The look of a giant papyrus without all the height. Height 24-30", depth 0-3"

Taro, Black Magic- (Colocasia esculenta "Black Magic") Incredible dusty charcoal black leaves dark burgundy, almost black stems. Height 4 feet. Depth 0-4 inches.

Taro, Imperial - (Colocasia antiquorum)

Its green leaves have an infusion of violet black color in each leaf, every one being slightly different. Royal appearance indeed. Height 24-30 inches, depth 0-4 inches.



Dwarf Giant
Papyrus

Umbrella Palm - (Cyperus alternifolius) 2-4 foot stems with umbrella like leaves. Small white flowers in summer. Likes marshy ground or shallow water and full sun. Grows well indoors.

Umbrella Palm, Dwarf - (Cyperus alternifolius "gracilis") The most popular of the umbrellas, due to its diminutive growth habit. The leaves are short like that of the Giant. Use in combination with Taros and Cattails for an array of pleasing textures and heights. Height 24-30 inches, depth 0-2 inches.

Water Canna - Available in an array of colors - yellow, orange, red, salmon, variegated foliage - with either bronze or green leaves. Blooms freely throughout the season. Height 3'-5', depth 0"-12"

Water Poppy - (Hydrocleys nymphoides) 5 inch yellow flowers. Floriferous. Creates a carpet of green leaves on the water surface. Height 2 inches, depth 2-4 inches.

Water Hibiscus - Excellent burgundy colored foliage with red flowers opening in the evening. Height 24-36 inches, depth 0-4 inches.

Water Snowflake - (Nymphoides indica) White snowflake shaped flowers throughout the summer. Small round leaves float on the surface of the water. Depth 0-4 inches.



Canna

Floating Plants

Plants in this group are fascinating and desirable as they grow and thrive by merely floating on the water's surface. The shade they afford restrains algae growth. Roots provide fish spawning beds and newborn protection. These plants grow easily; control by scooping out excess. Treat them as annuals and remove at first frost.

Frog's Bit - (Limnobium spp.) Shiny smooth leaf surfaces are supported underneath by thick spongy tissue. Light green undersides show slightly for contrast.

Water Hyacinth - (Eichhornia crassipes) Shiny buoyant foliage, lavender blue flowers. Excellent for goldfish breeding.

Water Lettuce - (Pistia stratiotes) Also called "Shell Flower". Pale green foliage; feathery roots ideal for spawning.



Submerged Plants

These plants play a vital role in your water garden. They deprive algae of mineral salts and sunlight which are needed by the algae to flourish. They provide oxygen, food, shelter, and a place to spawn for your fish. They also absorb the carbon dioxide given off by the fish. Oxygenators are supplied in bunches of unrooted cuttings which should be anchored in pots filled with soil or sand and topped with gravel to promote growth.

Hornwort - (Ceratophyllum demersum) Submerged but unrooted bright feathery green foliage. Easy to grow.

Rotala - (Rotala rotundifolia) Pointed short (1/2-3/4" long by 1/8 inch wide) leaves underwater. Pale pink flowers on terminal heads of stems.

Bacopa - (Bacopa caroliniana) Slow growing stem plant with oval shaped leaves. The leaves are light green and with sufficient light the top leaves get a bit red.

Mint - (Mentha aquatica) Aromatic smooth foliage.

Red Ludwigia - (Ludwigia mullertii) Glossy, olive-green leaves above with reddish undersides. The slender stems bear small yellow flowers in the leaf axils. It is a very good submerged oxygenator and tips the water surface with creeping runners.



Fish

Our fish supply is continuously being restocked with new sizes, colors and varieties of fish. The following is a description of fish that we generally carry. Stop by and pick out your favorites.

Goldfish Varieties

Comets

Although colored like regular goldfish, Comets have flowing tails often as long as their bodies. They too are hardy in colder climates and add character to a water garden. A comet grows approximately 1” per year up to 10-12”.

Sarasa Comets

A Sarasa Comet is a comet variety that has a body that is colored both red and white. Each has a different pattern of the two colors. These fish are hardy to cool climates and can grow to 12 inches at a rate of 1” per year.



Shubunkins

Shubunkins are a variety of goldfish that are colored a combination of white, blue, gray and red. Shubunkins are typically mottled with two or more of these colors and each pattern is unique. Since they are a comet variety they will grow to 10-12” at a rate of 1” per year.



Wakin

The Wakin goldfish has a slender body, somewhat similar to a Comet Goldfish, but with a differently shaped tail. The Wakin Goldfish has a more fantail shaped caudal fin, but the fin is not very long. The major colors of the fish are bright red and crisp white, which can form intriguing color patterns. Every Wakin will display an individual color pattern and the fish usually looks most striking when watched from above.

Please Be a Responsible Pond Owner

Comets and Koi found in most back-yard garden pond are non-native fish. This means they should never be released into the wild. If you have fish that you can no longer keep please try to find a home for them other than the local streams, lakes and ponds.

The same goes for plants. Each year more of our favorite aquatic plants are added to the invasive plant list prohibiting us from having them in our back-yard pond. If your plants are too much for your pond please compost them rather than tossing them into local waterways.

Koi Varieties

Koi

Koi are considered to be the largest of the pond fish. They are a member of the carp family and can reach lengths of 2 feet or more. They grow quickly when feed a balanced diet when they are young – easily 3” per year. As the koi matures, the growth rate slows down and the color patterns become more stable. These pond fish can easily outgrow a small pond so be sure your pond is large enough and do not over stock when fish are small. The Koi are most known for the vibrant colors on their backs and heads. Each of these color patterns has a Japanese name. Koi can be easily trained, are very friendly, and long lived. Originally bred in Japan, these fish are now being bred in the United States and Israel. Koi can be aggressive in a pond. Due to their growth rate, their appetite for pond plants can leave a new water lily leafless in just a day.



Blue Ridge Fish Hatchery



Butterfly Koi

These longfin members of the carp family are a wonderful addition to the water garden. They have the same growth rates, color patterns and life span as their standard fin counterparts. While their body and colors can be the same as found in other koi, their extra-long fins float beautifully through the water.

Blue Ridge Fish Hatchery

Stocking Your Pond With Fish

Stocking of a new pond should be done gradually. Adding too many fish at one time will compromise the quality of the water and may result in fish death. Add no more than 1/3 of the recommended amount of fish at a time over a 3-6 week period. Proper stocking levels depend on the fish (comet vs. koi), volume of water and the amount of filtration just to name a few considerations. New fish should be quarantined for a minimum of 3 weeks before adding to your existing pond fish.



EvoFeed Auto Fish Feeder

The feeder is designed to use pellets from 3-10 mm diameter. We do not recommend the use of sticks, flakes or other shapes of food. The rechargeable lithium battery only needs an overnight charge indoors, to then operate for at least 3 months powered by its own battery, depending of the timer setting. Adapter for charging is included. The feeder will work as normal when adapter is plugged in. evoFeed Automatic is specially designed with a strong motor and extra bottom ventilation over the impeller to prevent the food from clogging. Fixing pegs are included, which makes it easy to place and secure the feeder at the edge of your pond.

\$349.99

Fish Food

Blue Ridge Fish Food

Floating Koi and Goldfish Food

Provides a completely balanced nutritional diet that greatly enhances growth in all koi and goldfish. Contains a special blend of vitamins and minerals that promotes resistance to stress and immunity to diseases. Use large pellets for fish larger than 5" and mini pellets for smaller fish. The blend offers both sizes in one bag. The Cool Water Wheat Germ provides improved digestibility at low temperatures when koi and goldfish's metabolism slows. Feed when water temperatures are below 60 degrees (available in large pellet only).

2 lb \$ 16.99 5 lb \$31.99 25 lb \$139.99



Platinum Pro

Professional, fish meal-based diet formulated for discerning koi keepers that want the very best for their fish. This is a higher protein formula that will provide your koi with exceptional growth, nutrition and coloration. It contains everything needed to keep your fish in top show condition including top quality protein, carbohydrates and amino acids. It contains proven color enhancers Spirulina and Canthaxanthin for superior color enhancement. Also includes Primilac, a probiotic immune stimulant designed to protect koi from sickness and disease.



4.5 lb re-fillable jar \$43.99 (refill price \$32.99) 14 lb bucket \$124.99 (refill price \$93.74)

Probiotic Plus

Specially formulated with Primilac, Vitamin C and Montmorillonite Clay to boost koi and goldfish immunity, prevent disease and infection, and keep fish happy and healthy.

- Increased immunity to bacterial infection, reducing the chances your Koi fall victim to ulcer disease, fin rot and tail rot
- Improved digestion
- Increased growth rates
- Enhanced coloring, including deeper reds and crisper whites
- Essential minerals and trace elements that are typically filtered out of municipal water sources

2 lb \$19.99 5 lb \$38.99



Koi Krunchies

Ideal for hand feeding goldfish, Koi and other pond fish. High quality natural ingredients. Good source of vitamin C. Wonderful addition to your fish's regular diet. Contains real fruit flavors, and provide a great source of vitamin C, which is linked to proper tissue formation and proper digestion. \$22.99



PondMax Fish Food

Color Enhancing or Spring and Fall Wheat Germ

Specially formulated ingredients create a high quality and perfectly balanced nutritional diet. Quality food minimizes fish waste, which keeps your pond cleaner and your fish healthier.

2 lb \$15.99
5 lb \$29.99
10 lb \$52.99



Thermometers are
a must for a pond \$8.99





Tetra

Tetra Pond Sticks

This fish food is an economical food easily digested and containing full nutritional values required for all pool and pond fish.

1L	\$ 9.99	7L	\$27.99	15L	\$54.99
4L	\$20.99	10L	\$39.99	25L	\$71.99

Tetra Koi Vibrance

This is a premium color enhancing food which will increase growth and color in all koi.

1L	\$ 9.99	10L	\$48.99
4L	\$26.99	15L	\$64.99
7L	\$36.99	25L	\$92.99



Tetra Growth Food for Koi

Offers a specially balanced diet laden with proteins, vitamins, and minerals to promote growth, color and vitality.

1L	\$ 11.99	7L	\$49.99
----	----------	----	---------

Tetra Spring and Fall Diet

This wheat germ fish food transitions fish in and out of winter Easily digestible sticks.

1L	\$10.99	4L	\$29.99
----	---------	----	---------



Tetra Pond Flakes

The "primary meal" for goldfish and small koi. Easily digested enabling your pond water to stay clean and clear.

1L	\$9.99
----	--------



Tetra Vacation Food

Slow release feeder block. For all pond fish. Gel based block will not cloud water. For 15-20 Goldfish. use 1 block per 7 day period. For 2-3 large medium koi use 1 block per 7 day period Use multiple blocks for more or larger fish. \$8.99



Only feed fish as much as they will eat in 5 minutes
A floating fish food is best so that you can see that they are eating it as well as examine the fish as they come to the surface for food.

Frequency and the amount of food should vary with water temperatures.

- Below 45F – do not feed**
- 45-60F – feed 3-5 times per weekly**
- 60-85F – feed 1-2 times daily**
- Over 85F – do not feed**

If you are in doubt about if to feed, it is always best to underfeed rather than overfeed. Overfeeding will result in poor water quality.



ReptoMin Turtle Food

Floating Food sticks for aquatic turtles, newts and frogs with Calcium and Vitamin C. Easy to digest formula is scientifically formulated with the latest nutritional and manufacturing technologies.

10.59 oz	\$18.99	2.64 lb.	\$38.99
----------	---------	----------	---------

Alternative to Manufactured Fish Foods

Changes in your fish's diet will stimulate their appetite and alleviate boredom. However, their main source of food should still be manufactured foods. Use "people food" as snacks only occasionally. Manufactured foods contain the proper balance of vitamins and minerals needed for good fish health

Carbohydrates for quick energy

(keep limited)

- Cheerios
- Wheat Bread
- Potatoes
- Noodles

Vitamin C for Color

- Oranges
- Grapefruit
- Lime
- Melon
- Watermelon

Vitamin A,K,C and folic acid

- Azolla
- Peas
- Spinach
- Leaf Lettuce

Protein

- Insects
- Earthworms
- Shrimp

Water Clarity and Fish Care

These products only work well if they are used in conjunction with a pump and filter. Keep in mind also that an ecologically balanced pond will need less chemical intervention to keep healthy.

Water Conditioners

Stress Coat

Stress Coat replaces the natural mucous slime coating on the skin of fish damaged in handling, netting, and times of stress. The aloe vera promotes the healing of damaged skin.

16 oz	\$18.99	64 oz	\$49.99
32 oz	\$31.99	1 gallon	\$89.99



For use when adding new water or complete water changes.

Municipal water supplies are treated to make water safe for humans but it can be toxic to fish.

Even if you have well water, you fish will benefit from these water treatments which add their slime coat or remove heavy metals.

Pondmax Detoxmax +

Immediately removes chlorine, chloramine, and heavy metals that are often present in city water supplies. Also adds a slime coat protectant to the water to help fish heal wounds and abrasions and protect them in times of stress (during water changes & clean outs).

8 oz Liquid	\$11.99
16 oz. Liquid	\$20.99
32 oz. Liquid	\$30.99
64 oz Liquid	\$49.99
1 gallon Liquid	\$89.99



Dry Ammonia Remover with ChlorAm-X

Removes & Detoxifies: Ammonia, Chloramines & Chlorine. For fresh & salt water. Suitable for use with fish & shellfish intended for human consumption. 1 oz. of ChlorAm-X will treat 235 gals. of water. It will remove 1 ppm of total ammonia, 3.2 ppm chloramines and 2.0 ppm chlorine.

1 lb \$34.99 treats 3760 gallons



For removal of toxins in the water

It is recommended that a season long bacteria treatment be used to keep toxic ammonia and nitrites from getting high.

Re-test water on a regular basis

Aquascape Activated Carbon

Removes discoloration and odors in pond water. Made with bamboo carbon, a sustainable resource with incredible ability to remove discoloration from water. The highly effective carbon also removes chlorines and chloramines from the water which can prove harmful to pond fish.

1 bag treats 800 gallons 2.2 lb \$29.99



Algae Control

Rock and Waterfall Cleaner Liquid

Commercial strength oxy-based cleaning. Quickly and effectively cleans rocks, waterfalls, water features and fountains. Lifts debris to pond surface where it can be removed by net or skimmer.

Simply pour into area with most active water movement for best mixing. Safe for use with fish, birds, pets and wildlife

1 oz treats 300 gallons

32 oz \$19.99

Gallon \$39.99

Rock and Waterfall Cleaner Dry

Powdered formula bring powerful oxygen based cleaning to ponds.

Dry material must contact the debris then lifting it to the pond surface where it can be removed by net or skimmer. Safe for use with fish, birds, pets and wildlife.

1 lb treats 300-400 square feet

2 lb \$21.99

8 lb \$49.99

25 lb \$129.99



AlgaeStop

Works fast to stop algae growth and control formation of new algae. 9% concentration of active ingredients. 1 oz treats 600 gallons.

16 oz \$19.99 32 oz \$49.99

2 oz \$29.99 gallon \$109.99



Algaefix

A liquid algae control for use in ornamental fish ponds and water gardens containing fish and plants. Controls filamentous algae, also known as string algae, hair algae or blanketweed. Kills existing algal blooms while helping to control future ones. Not safe for snails.

8oz \$11.99 64 oz \$54.99

16 oz \$19.99 1 gallon \$89.99

32 oz \$31.99 2.5 gallon \$155.99



Pond Block

No measuring – just drop 1 block per 250 gallons into the pond.

When it dissolves add another to keep algae from growing.

4 blocks \$14.99

treats 1000 gallons



String Algae Chemical Kill

*For quick kill of string
algae*

*Always provide
vigorous aeration when
using products to kill
algae*

*Avoid using these
products during high
temperatures and late
in the day*



Fountain Blocks

Controls algae growth in ornamental water fountains. Helps clear cloudy water. Not recommended for use in fountains with live plants or fish. 6 pack \$9.99

Control Phosphate to Control Algae

Natural Phosphate Binder

Binds problem causing algae and provides approximately 70 beneficial trace minerals. Buffers pH.

1 scoop treats 500 gallons

2 lbs \$23.99

7 lbs \$69.99



Alkalinity Booster with Phosphate Binder

Helps to maintain proper water balance by increasing overall KH, pH and Alkalinity. Phosphate and ammonia free. 1 scoops treats 125 gallons, container treats 5000 gallons

1.1 lbs. \$19.99



Phosphate is one of the main nutrients algae needs to survive

Reducing phosphate levels can sometimes reduce algae growth

Use both algaeicides and barley products at the same time to combat string algae

Barley Straw

Floating barley to help reduce string algae as the breakdown occurs throughout the season.

2 pack \$14.99



Straw bales – last longer

Extract – less messy, works quicker

Will not kill existing algae, controls growth of new algae



Aquascape Barley Straw Extract

A pharmaceutical-grade, fermented barley extract. The added enzymes will help reduce pond maintenance by breaking down pond sludge and keeping filter pads cleaner.

8 oz \$19.99

32 oz \$39.99

16 oz \$24.99



Pond Dye

Pond dyes help filter out UV rays from the sun. Concentrated formula does not stain or harm fish, plants or other wildlife once dispersed in water (can stain in concentrated form). Gives a more reflective look to the water. 1 oz treats 1000 gallons. Black or Blue

16 oz \$14.99

A Word on Algae...

The single biggest pond headache is algae. Algae is a plant. It requires both a nutrient source and sunlight to thrive. Nutrients come from fish waste and excess fish food. Sunlight and shade conditions vary throughout the season. To help control algae keep a check on the following:

- ✓ Provide shade for the pond with floating plants and lilies.
- ✓ Keep your pond from becoming overstocked by culling fish in the spring.
- ✓ Keep your fish feeding to a minimum even though they may seem hungry
- ✓ Provide aeration in the pond paying attention not to create stagnant areas.
- ✓ Keep the pond clean of decaying organic matter such as leaves and plant material. (A spring cleaning will help this greatly.)
- ✓ Use phosphate reducers if necessary
- ✓ Barley can be effective at restricting the growth of string algae but not green water algae.
- ✓ UV Sterilizers will kill off green water algae but not string algae
- ✓ Algaecides are for a quick fix, bacteria are for long term maintenance.
- ✓ Algaefix works well on string algae, re-treatment will be necessary – this is an algaecide.
- ✓ Microbial Algae Clean works well on green water but it takes time – this is a bacteria.
- ✓ A beneficial bacteria must be used when killing algae of any type to break down the dead organic matter.

Microbial Algae Clean

This product contains patented bacteria to control green water algae in ponds with live fish and plants. The bacteria help establish and maintain a clean pond, free of algae. They also help improve dissolved oxygen levels and reduce noxious odors from the pond.

- Biological inhibitor of green water algae.
- Promotes a cleaner pond environment.
- Eliminates troublesome organic sludge and debris.
- Will not harm live plants or fish.

16 oz \$21.99



For Green Water
Biological Control

May take up to 3
weeks to see results
Continue to use
throughout season

Regular maintenance of a pond is the best way to avoid both water clarity and water quality issues. We recommend a bacteria treatment and algae control at least bi-weekly during the summer months as well as seasonal pond cleaning.

Flocculants

Clear Max

Unique properties allow suspended particles in water to attract together and fall to the bottom of the pond where they can be vacuumed out or removed by filtration. The result is clearer water.

1 oz treats 500 gallons.

16 oz \$19.99 1 gallon \$89.99

32 oz \$29.99



*Flocculants
clump particles
suspended in the water
column and drops them
to the bottom or into
the filter.*

Water Clarifier

Concentrated formula clears murky water. Attracts suspended particles together allowing them to settle out of the water column. Best when used with a beneficial bacteria to break down the debris. Great for use after rainfall of anytime pond is stirred up. 1 oz treats 1000 gallons

16 oz \$15.99

32 oz \$22.99

Gallon \$54.99



*Can sometimes help
with green water
particles*

Simply Clear

A bacterial based pond clarifier that quickly clears murky, cloudy water and keeps it clean and clear through natural bacterial action. This triple action formula acts fast – clears pond water and breaks down sludge and offers a long term solution to un-clear pond water.

16 oz \$21.99

32 oz \$39.99



*Use bacteria to break down
organic matter that
accumulates on the bottom
of the pond
See Dry Biological
Bacteria
pages 58-59*

Pure Pond Bomb

Beneficial bacteria. Rather than weekly treatments, drop the entire Pond Bomb into the pond to improve water quality. Can last up to 30 days depending on the organic debris in the pond.

For ponds up to 5000 gallons \$26.99

For small ponds Mini Balls \$21.99



Liquid Biological Bacteria

Easy Pro All Season Bacteria

Designed to work in spring, summer and fall on removing ammonia, nitrates, phosphates, sludge and improving water clarity in water gardens and koi ponds.

Dosage rate: 2 ounces per 1000 gallons

- 16 oz \$15.99
- 32 oz \$21.99
- 1 gallon \$69.99



***Jump Start your pond
in the spring with
biological bacteria.***

UltraClear Clarifier

Improves clarity, cleans the water, reduces organic build-up, and removes odors. UltraClear is the environmentally friendly way to beautify your ponds and fountains. Works naturally and actually benefits the environment. 100% safe for fish, wildlife, and turf.



- 12 oz \$14.99
- 32 oz \$26.99

***Use these nitrifying
bacteria to keep
ammonia and nitrite
levels in check during
the season***

Nite-Out II

This specialized bacterial additive rapidly breaks down nitrogen compounds. Establishes and maintains the necessary bacterial populations required to efficiently process toxic ammonia to nitrite and then to nitrate.

16 oz treats up to 960 gallons. \$21.99



BactiMAX

Natural beneficial bacteria to break down organic debris. Eliminates ammonia and nitrites. 1 oz treats 1000 gallons.

- 16 oz \$19.99
- 32 oz \$29.99



Pure + Filter Starter Gel

Live concentrated bacteria culture for use in new pond filters. The gel based solution will stick to the filter media allowing the nitrifying bacteria to rapidly colonize your filter.

Treats 2600 gallons
1 liter \$45.99



Product	Season	Description	Price
MicrobeLift PL	Spring, Summer	For clear ponds	\$21.99 pint \$34.99 quart
Spring/Summer Cleaner	Spring, Summer	Removes twigs & leaves	\$34.99
Autumn Prep	Fall, Winter	Winterization of pond	\$39.99



Dry Biological Bacteria

Sludger Remover Bacteria

This unique formulation is produced using a “no mess” powder in water soluble packets which immediately begins to dissolve upon contact with water. Reduces toxic ammonia and nitrite as well as a murky water caused by organic waste (sludge) on the bottom of the pond. Ideal for use with All Season Bacteria.

- 1 packet treats 1000 gallons
- 12 count \$19.99
- 24 count \$32.99
- 5 lb \$89.99



Pond Vive WG

Super concentrated blend of beneficial bacteria and enzymes. Reduce muck buildup and eliminates stale pond odors. Improves water clarity and reduces oxygen demand. Cold weather bacteria strains for results down to 38°F. 1 packet per 1000 gallons

- 12 packets \$25.99
- 24 packets \$43.99



Muck Digester Tabs

The UltraClear Muck digester Tab weighs one ounce and is roughly the size of a golf ball. They are easy to distribute over the pond surface. Randomly toss them over the surface and they sink to the bottom of the pond where they begin slowly releasing a combination of 9 strains of beneficial bacteria into the pond. The tab completely dissolves in 8 hours. Each tab contains 100% safe, natural ingredients. No harmful chemicals are used. Designed to be used in cold water as well as warm water. The tabs are effective in both the anoxic zone on the pond bottom as well in the more oxygenated areas. 1 tab treats 1000 gallons

- 6 tabs \$22.99
- 2 lbs \$62.99
- 4 lbs \$129.99



Dry bacteria should be used on a regular basis all season long

Breaks down organics in the pond including dead algae and decaying plant material

For Larger Ponds try



Lake & Pond Vive

The natural, biological way to revive your pond. This special blend of bacteria is designed to reduce sludge buildup, eliminate pond odors, improve water clarity, reduce oxygen demand, eliminate excess nutrients. Great for larger ponds. Pre-measured water soluble packets you just toss in. 2 packets treats ¼ acre new pond for 2 weeks, use 3 packets every 2 weeks for older ponds.

- 10 lb pail (20 packets) \$154.99
- 5 lb pail (10 packets) \$89.99

Aqua Defend

Combines 3 powerful ingredients into one easy to use treatment. It contains a proprietary blend of all natural bacteria, enzymes and ingredients to buffer pond water and help keep rocks and waterfalls clean!

- ✓ Bacteria blend is especially effective at breaking down waste and sludge build-up
- ✓ Additive to help prevent build-up on rocks, waterfalls and streams *
- ✓ Additive to bind phosphates, buffer pH and help settling of particles.

2 oz treats 1000 gallons
1 lb \$29.99
2 lb \$54.99
5 lb \$89.99

*when rock, waterfalls and streams need a more thorough cleaning use Rock and Waterfall Cleaner



Cool Water Bacteria



Winter Blend Bacteria

Specifically formulated for fall-winter-spring treatment of your pond. Its probiotic formulation of select beneficial bacteria ensures your pond has the required bacteria to maintain a clean pond & healthy fish during the colder months. Start using when water temperature falls below 55 degrees F. Use 1 oz per 1000 gallons of water. \$35.99

Aquascape Cold Water Bacteria

Contains 7 pure strains of concentrated beneficial bacteria that go to work quickly cleaning and balancing your pond, works at temperatures below 50F or 10C.
250 ml treats up to 5000 gallons \$16.99
500 ml treats up to 10,000 gallons \$27.99



Microbelift Autumn Winter Prep

Helps accelerate the decomposition of leaves, sediment and other organic matter during the fall and winter months. MICROBELIFT/AWP will also jump start your pond to a healthier environment in the spring. Liquid and dry packet combination. \$39.99



*Switch to Cold Water
Bacteria during spring
and fall for best results
at breaking down
organics*

Fish Medications

***A veterinarian should be consulted to determine what type of infection you have in the pond before treating a pond. Mixing medications or overmedicating can do more harm than good in a pond.
Good Water Quality = Healthy Pond***

Pondmax ParaMax

A broad spectrum treatment for a variety of parasites, bacteria and fungus including anchorworm, fish lice, flukes, ichthyophthirius (Ick), trichondina, costia and chilodonella. 1 oz per 60 gallons. Use 3 times over 2 week period.

16 oz.liquid \$29.99
32 oz liquid \$59.99
Gallon \$219.99



Pondmax MediMax



Excellent for controlling gill diseases in pond and aquarium fish. Bacterial diseases generally result from fish stress due to adverse water quality conditions (pH, oxygen or temperature problems),

habitat clean-outs, untreated abrasions or predators. ½ oz per 300 gallons. Use 3 times over 2 week period. 8 oz granular \$20.99

Melafix

All natural fish medication. Effective antibacterial remedy for pond fish. Also causes rapid repair of damaged fish tissue. Treats ulcers and open wounds.

16 oz \$24.99



Terminate by Aquameds

Specially formulated treatment for salt resistant parasites and fungal disease! Formulated with Malachite Green and Formalin (MG&F). Terminate is very safe for treating costia, chilodonella, ich, oodinium and fungal infections. 32 oz \$49.99



- Safe to use on "scaleless" koi.
- Will not set back your filter.
- Can be used in water temperatures as low as 50°F
- Treat for 3 days and you're done, as compared to 9 days of most MG&F products.

Notes: Do NOT use salt or any other medicated treatments when using Terminate. Do NOT use with invertebrates. Can stain - wear protection.

Remember there are bacteria and parasites existing in most pond systems and any stress of the fish will weaken the immune system and give these pathogens a "way in".

Check your water quality to be sure pH, Ammonia, and Nitrite are at healthy levels to prevent additional stress when treating for infection.

For Parasitic Infections a scraping of the slime coat of the fish should be examined under a microscope to determine the presence of parasites.

Remember when using Medications in the water that some of your nitrifying bacteria may be killed off and oxygen may be depleted. Keep a close check on ammonia and nitrite levels as well as dissolved oxygen.

Water Enhancers for Fish

UltraClear Koi Clay

Benefits your Koi & pond fish in several ways. It provides valuable trace minerals including calcium, magnesium and other trace elements for improved bone and scale growth, blood clotting and reduced loss of sodium and potassium from fish blood. It contains essential silica for removing harmful toxins and heavy metals. UltraClear Koi Clay also helps create an ideal habitat on the pond bottom for Koi fish to thrive and flourish. UltraClear Koi Clay is 100% Bentonite Clay. The geometrically unique surface of the Bentonite Clay and the size of the particles is critical for bonding with and absorbing toxins such as heavy metals and pesticides that may enter the pond habitat. UltraClear Koi Clay helps to maintain a clear, high quality water environment for your Koi or gold fish in your pond. Add 2 tablespoons per 1000 gallons each week. Increase frequency if the problem persists or the load increases.

4 lb \$39.99



Easy Pro Pond Salt

99% pure-made from evaporated seawater. Additional electrolytes. Reduces fish stress and improves disease recovery. Enhances fish's natural slime coat.

Use 1-2 lbs per 100 gallons

10# \$21.99

20# \$34.99

50# \$69.99



Salt is beneficial to fish but not well received by plants at heavy doses.

Pond Care Pond Salt

An all-natural sea salt that replaces electrolytes which fish lose in times of stress, including potassium, sodium, chloride, calcium, & magnesium. All of these are essential for the uptake of oxygen & the release of carbon dioxide & ammonia. Made from evaporated sea water (not just a table or rock salt). Helps eliminate the toxic effects of nitrite. Improves fish gill function.

4.4 lbs \$12.99



Once added to the pond salt will remain until it is pumped out – it will not evaporate out with water.

Many de-chlorinators provide enhancements to water for the benefit of the fish as well. Pondmax Detoxmax, Stress Coat, and Aquascape Pond Detox all contain additives to replace the natural mucous slime coat of the fish.

Accessories

Test Kits

A helpful way to prevent fish disease or mortality is to test your pond water. Pond fish are especially effected by pH and ammonia levels of the water. KH/Alkalinity has a direct relationship on how well your pond is buffered against pH swings and crashes.

KH/Alkalinity Test Kit - \$29.99

Liquid pH Lower 32 oz \$19.99

Liquid pH Higher 32 oz \$19.99

Alkalinity Booster \$19.99

Pondmax pHMax Reducer Salts 2 lb \$24.99



API Test Kits	
pH	\$9.99
Ammonia	\$19.99
Nitrite	\$9.99
KH	\$9.99
Multi Test Strips	\$18.99

Many factors contribute to the fluctuation of water parameters such as pH, Ammonia and Nitrite just to name a few. Test your water periodically to be sure it is safe for fish and plants while also balanced to enhance water clarity.

Important tests are those for pH and Ammonia. Pond fish prefer a pH of between 7.0 and 8.0. They can adjust to a lower or higher pH. However, you need to be aware of your pH level when introducing new fish to the pond. Ammonia can be highly toxic to pond fish. If your pond is overloaded with fish or you are overfeeding your fish, the ammonia levels may be getting high. The best way to combat high ammonia is by partial water changes when you notice the levels beginning to rise, then locate and relieve the problem.

For Plants

Pondtabbs Tablets

Aquatic plant food. Feed your aquatic plants to maximize beauty and get the most out of your plant investment. These plant food tablets were formulated to feed all pond plants while not releasing chemicals into the water that would encourage algae growth.

20 tablets \$ 8.99

60 tablets \$18.99

300 tablets \$79.99



Once Per Year Fertilizer

Aquascape Once-A-Year Pond Plant Fertilizer 11-3-14 (NPK ratio) is a specially designed time released formula that was created to optimize the growth of aquatic plants. Formulated to feed for 180 days, with no excess nitrogen to stress the plant and low phosphorus to reduce the risk of algae growth. The high potassium in the formulation encourages incredible flowering for aquatic plants. Perfect for fertilizing waterlilies, lotus and other pond plants. This once-a-year fertilizer will maximize plant growth and increase flower production for the entire year.

6 pack \$24.99

12 pack \$44.99



Organic Top Soil

A heavy mix of soil ideal for aquatic plants.
\$9.99

Lily & Lotus Pots

Water lilies and lotus grow best in larger containers
Round 15"x8.5" \$13.99
Round 19.5"x9.5" \$24.99

Tips for Growing Water Lilies
6 hours of sunlight or more
Fertilizer every 2-4 weeks during summer months
Trim dead foliage & flowers
Repot every 2-3 years



Mesh Plant Containers

These black baskets are excellent for planting aquatics since they allow the roots to breath and reach the water easily. The black growing pots contain no holes in the bottom and are excellent for lilies and lotus in the larger sizes.

Baskets

Medium Round (8") \$4.99
Large Round (10") \$7.99

Large Square (12") \$9.99
Contour (18"x7") \$9.99



Floats for Baskets

Best used with low growing marginals
For 8" Round \$19.99
For 10" Round \$32.99

For 9" Square \$32.99
For 12" Square \$49.99
For Contour \$34.99



Floating Plant Bags

No shelves in the pond – no problem. These floating plant bags will help keep shallow water plants close to the surface in the pond .

10" \$19.99
14" \$24.99
18" \$32.99



Fabric Planters

Made from fine, porous material, the planters allow water in while preventing soil from entering the pond, helping to keep your pond clean and clear. The flexibility of the material prevents them from breaking or cracking and makes it simple to place the plants in tight spaces where typical plastic pots may not fit. The black color of the planters allows them to easily blend in with their surroundings. Two planters are included.

6" \$6.99 12" \$9.99
8" \$7.99 14" \$12.99

Heavy Duty Fabric Planters

A more professional take on our existing line of aquatic planters. Constructed from a non-woven geotextile, these professional grade pots are thicker and more rigid, which helps maintain the wall structure over time. The pots are still flexible allowing them to conform to spaces inside your pond. The fabric pots allow for oxygen transfer through the pot walls encouraging the development of healthy feeder roots for the plants. Because these pots were designed for larger aquatic plants, we included heavy duty nylon handles that go all the way around the pot, making it easy to maneuver in and out of the pond.

12" \$16.99 20" \$24.99
16" \$18.99



Pond Nets

Model	Bag Shape	Handle Length	Price
Pond Net (loose black mesh)	Rectangle 12"x7"	Telescope to 63"	\$22.99
Skimming Net (tight white mesh)	Rectangle 12"x7"	Telescope to 63"	\$22.99
Large Pond Net (loose black mesh)	Triangle	Telescope to 63"	\$38.99
Large Skimming Net (tight white mesh)	Triangle	Telescope to 63"	\$38.99
Fish Net (loose black mesh)	Round 22" diameter	Telescope to 69"	\$48.99
Professional Pond Net (loose black mesh)	Triangle 20"x23"	40"	\$79.99



Nets to Cover Pond

Aquascape Protective Pond Netting

Keeps predators out while catching leaves and falling debris before they enter the pond. The reusable netting is easy to install and made of quality woven poly material that resists tearing. Each net comes complete with landscape stakes.

- 7'x10' \$16.99
- 14'x20' \$31.99
- 28'x30' \$72.99

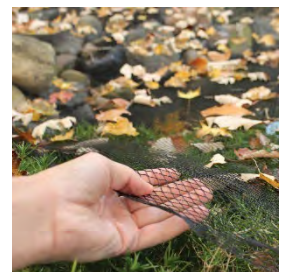

Easy Pro Pond Netting

Strong black netting is protected with a UV coating to last. Includes stakes.

- 15'x15' \$28.99
- 20'x30' \$74.99
- 20'x20' \$56.99



Easy Pro Deluxe Pond Cover Tent

Complete pond and garden protection for leaves and unwanted pests! Simple two person assembly can be completed and installed in just a few minutes. Strong 3/8" nylon black mesh netting will last for years. Dark mesh allows for easy viewing of pond with tent in place.

- 8'x10' \$164.99
- 13'x17' \$289.99
- 10'x14' \$209.99



Dalen Netting

This black netting provides coverage for your pond from wildlife. Use it in the fall to catch the falling autumn leaves from entering into the pond. Tent it over the pond so the leaves roll off to the sides. Be sure to remove your net before the first snowfall to keep it from sinking into the pond.

- 7'x10' \$16.99
- 14'x14' \$26.99
- 28'x28' \$72.99
- 28'x45' \$89.99

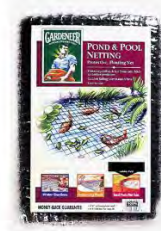

For Fall and Winter

Microbelift Autumn Winter Prep

Helps accelerate the decomposition of leaves, sediment and other organic matter during the fall and winter months. MICROBE-LIFT/AWP will also jump start your pond to a healthier environment in the spring. Liquid and dry packet combination. \$39.99



Winter Blend Bacteria

Specifically formulated for fall-winter-spring treatment of your pond. Its probiotic formulation of select beneficial bacteria ensures your pond has the required bacteria to maintain a clean pond & healthy fish during the colder months. Start using when water temperature falls below 55 degrees F. Use 1 oz per 1000 gallons of water. \$35.99

Aquascape Cold Water Bacteria

Contains 7 pure strains of concentrated beneficial bacteria that go to work quickly cleaning and balancing your ornamental pond, works at temperatures below 50F or 10C. Aquascape Cold Water Beneficial Bacteria contains a specific combination of bacteria that are most effective at doing two jobs- reducing organic material such as leaves and pond sludge and reducing ammonia, nitrite and excess nutrient such as phosphate that are known to cause poor water quality and unsightly water conditions.

250 ml treats up to 5000 gallons \$16.99

500 ml treats up to 10,000 gallons \$27.99



Aquascape Smart Pond Thermometer

This specially designed pond thermometer is easy to connect to your smartphone or tablet, allowing you to easily check the temperature of your pond or water feature using the [Aquascape Smart Control App](#). Use the immediate and accurate temperature data to adjust fish feeding schedules, change water treatments, and more. The product also includes an integrated display panel for monitoring temperature without the use of a tablet or smartphone. The durable, spherical design is weighted to sink and built to last in all weather conditions, capturing temperatures between -20°F and 120°F (-28°C and 48°C). Compatible with iPhone and Android operating systems and adequate wireless coverage is required (2.4 GHz supported). 3 year limited warranty. \$79.99



Winter Tips

- *Stop feeding fish when water temperature drops below 50F*
- *Trim and remove dead foliage on plants*
- *Add fall bacteria to breakdown organic matter*
- *Remove the pond net before the snow falls*
- *Wait 2 weeks after last fish feeding before shutting down pumps and filters*
- *Start Aerator immediately after pump is shut off and run continually*
- *Turn on De-Icer when aerator is no longer keeping adequate hole in ice*

Country Gardens
(978)948-2124



Atlantic Typhoon Aeration Kits

Dependable aeration for smaller ponds 5’ deep or less. They have replaceable diaphragm cartridges for an extended pump service life. It comes with weighted air stones with rim guards that stand up to multi-season use. Include an air pump with a 6’ cord, 4” air stones, in-line check valves and tubing. 3-year limited warranty.

Single Outlet	For Ponds Up to 1000 gallons	\$79.99
Dual Outlet	For Ponds Up to 2000 gallons	\$121.99



We recommend a combination of air pump and de-icer during the winter months. In this area, typically an aeration will only keep a hole open in the ice in temperatures above 15F.

Atlantic Typhoon Professional Aeration Kit



A high output for larger water gardens and koi ponds with greater oxygen demands. Its high efficiency non-clogging diffuser tubing is less restrictive than stones or rubber diaphragms for greater flows and a long pump life. The circular diffuser design maximizes upwelling and water circulation and gas exchange. The diffusers come unweighted and will require filling with your choice of sand or gravel. Includes an air pump with a 6’ cord, 8” diffuser, fittings, in-line check valves and 20 feet of weighted tubing. Maximum depth of 7’ and a pond volume of 6,000 gallons. 3-year limited warranty.

Complete Kit	\$302.99
Pump Only	\$172.99

Keep your Aerator running continually but the de-icer can be turned on and off (or kept on a timer) as needed to provide an adequate opening in the ice.

KLC Koi Pond Aeration Kit

Give your pond some Koi Loving Care! Ensure adequate oxygen and circulation during hot summer months and de-icing capability during freezing months. Dual linear diaphragm compressor provides maximum air output, quiet and energy efficient, safe for fish, pets and family with no electricity in the water. 3 year limited warranty. Includes compressor with 6’ power cord, rubber membrane diffuser, connectors and 3/8” Quick Sink tubing.

LA1	\$329.99	Replacement Diaphragm	\$44.99
-----	----------	-----------------------	---------



Aquascape Pond Air 2

Extremely energy-efficient, quiet, simple to use and maintain, comes complete with winter resistant air line, preassembled check valves and weighted air stones. \$89.99

Replacement Air Disc	\$14.99
Rebuild Kit	\$32.99



Aquascape Pond Air Pro 60

Professional-grade aeration system is designed to help improve water circulation and increase oxygen throughout the pond. Comes complete with a weather-proof, outdoor-rated, energy-efficient 45-watt air pump. High volume 2.1 CFM of air. For ponds up to



10,000 gallons. Includes one large 8-inch diameter aeration disc and 30-feet of 3/8” braided aeration tubing. \$449.99

De-Icer Maintenance

De-icers should be cleaned and stored for the spring and summer. Examine for corrosion. Before putting in the pond for the winter, test the de-icer by putting it into a freezer 2-3 hours. Take out and immediately plug into GFCI protected outlet. The light on top of the de-icer should turn on and it should not trip the GFCI. Check again when it is placed in the water to be sure the GFCI is not tripped. Tripping indicates seals broken down and you should replace de-icer. Please be sure to always plug pond items into a GFCI outlet.

Laguna 315 watt De-Icer

Safe for plastic and liner ponds. Includes a highly visible LED light that indicates when it is on. Thermostatically controlled on/off feature saves energy. 315 watts, 22' power cord \$139.99



Laguna 500 watt Power Heat

Maintain a vent hole at the pond surface for proper gas exchange. Stainless Steel housing for even heat distribution and corrosion resistance. Safe for plastic and liner ponds, will not harm fish or plants. Dual zone integrated thermostats. LED power indicator on top lets you know unit is on and when it is heating. \$209.99



Atlantic 300 watt De-Icer

Saves energy by cycling on and off. Constructed of high strength and high temperature PPS polymer for incredible durability under the most adverse conditions. Internal thermostat turns heater on just above freezing and off as water warms for fully automatic operation. Efficient heating element only draws 300 watts when needed to keep operating costs low. \$92.99



Aquascape Smart Control Plug

Allows you to control and monitor outdoor electronics from your anywhere using your Smart phone or Tablet. The plug features three outlets so you can control three products simultaneously. Adequate wireless coverage is required (2.4 GHz supported). 3-year limited warranty \$79.99



Make regular checks on your de-icer and aerator throughout the winter to be sure they are working properly

Each pond differs based on fish load and level of organic matter as to how large an opening is needed and how long the hole can close before fish health is compromised. Keep in mind that as your pond matures, additional winter care may be needed. Larger or more fish and heavily planted ponds need a larger hole in the ice for better gas exchange.



Pond Maintenance

Aquascape Smart Pond Thermometer

This specially designed pond thermometer is easy to connect to your smartphone or tablet, allowing you to easily check the temperature of your pond or water feature using the Aquascape Smart Control App. Use the immediate and accurate temperature data to adjust fish feeding schedules, change water treatments, and more. The product also includes an integrated display panel for monitoring temperature without the use



of a tablet or smartphone. The durable, spherical design is weighted to sink and built to last in all weather conditions, capturing temperatures between -20°F and 120°F (-28°C and 48°C). Compatible with iPhone and Android operating systems and adequate wireless coverage is required (2.4 GHz supported). 3 year limited warranty. \$89.99



Floating Thermometer

The most important tool you should have for your pond if you have fish. Feeding and activity of the fish are determined by pond temperature. Easy to read Fahrenheit and Celsius scales. Fluorescent marking. \$8.99

Mosquito Dunks

Safe to pets, children and the environment. Made with B.T. a naturally occurring biological organism which kill mosquito larvae by feeding on it before it becomes a biting adult. Will continue to kill mosquito larvae for 30 days or more. Each dunk covers 100 sq. Ft. of water surface. Use the Mosquito bits for a quick kill without lasting effects.

- 6/card \$14.99
- 2/card \$11.99
- Mosquito Bits 8 oz \$13.99
- Mosquito Bits 32 oz \$19.99



Pond Construction

Waterfall Foam

Use foam to help control water direction in your waterfall. This foam will set up a barrier between your pond liner and stone to move the water over or between rock in the waterfall.

- Aquascape Single Use Can 12 oz \$19.99
- Easy Pro Single Use Can 20 oz \$27.99
- Multi Use Can \$41.99 (must be used with a foam gun)
- Foam Gun Cleaner \$41.99
- Economy Foam Gun \$72.99



Bulkhead Fittings

Need to cut a hole for plumbing. Bulkhead fitting provided a threaded through liner fitting for attaching pvc fittings.

- 1 ¼" \$15.99 2" \$21.99 4" \$175.99
- 1 ½" \$18.99 3" \$72.99



Seaming Liner

Quick Prime Plus & Liner Tape

A must when joining two pieces of liner. Use the QuickPrime with the Liner Tape for best results.

Quart LVOC- \$129.99

One Sided Tape – 6” wide \$4.99 per foot

Double Side Tape – 3” wide \$3.99 per foot



Terminating Liner at a Hard Surface

Adhering liner to a flat surface can be done using a termination bar. The bar has pre-punched holes in 4” increments. Use every hole when terminating underwater, every other hole above water.

10” Aluminum Bar \$59.99

Concrete Anchors \$4.29 each

Ball Valve

Control the flow of pumps or just add back pressure to your pump by installing a ball valve within the pvc tubing. Socket fittings allow you to glue pvc for easy installation.

2” \$19.99

1.5” \$15.99

1.25” \$15.99 (other sizes available)



Flexible Rubber Coupling

Rubber coupling with stainless steel clamps on both ends for easy on and off. Use any place you regularly disconnect you pvc pipe. The elbow is great for use in a skimmer box.

	Straight Coupling	Elbow
1 ½”	\$9.99	\$9.99
2”	\$10.99	\$10.99
1 ½” / 2”	\$19.99 for joining 1 ½” to 2’ pipe	



Diverters & Fountains

Triton 3-Way Diverter

Manifold designed exclusively for pond-free fountain installations. The 1 ½” inlet will not restrict the flow of water into the manifold, thereby delivering maximum volume to each of the three outlets. True “ball” style valves with removable handles enable small flow adjustment to be made to each outlet independently. The compact design makes it a perfect fit for installation in all pump vaults and fountain basins.

\$33.99



Easy Pro Statuary Splitter

½” and ¾” stepped barbed fitting on inlet and outlet. Individual flow control valve on each line. \$19.99



Pondmaster Diverter Valves

Comes with female coupling, threaded outlets and diverter valve

Model	Fits Pumps (GPH)	Thread Size	Price
#02099	250-700	1/2" male	\$19.99
#02090	950-1800	3/4" male	\$21.99
#02092	2400-3600	1" male	\$21.99



Water Movement

We have a variety of spitters that can be added to a pump to create water circulation that are decorative to the pond.

- Lazy Frog on Lily Pad \$81.99
- Fairy Planter \$109.99
- Turtle on Log \$81.99
- Double Turtle on Log \$109.99
- Silly Snail \$119.99
- Jazz Frog \$119.99
- Toucan Spitter \$149.99
- Koi Spitter \$59.99



Fountain Heads

Compatible with the Atlantic MD Pumps, these versatile fountain heads pivot to make leveling easy, telescope to adjustable heights and feature four different spray patterns to choose from.

MDFH1020 - for use with MD1000-MD2000 \$30.99
Minimum height 15" – maximum height 22"

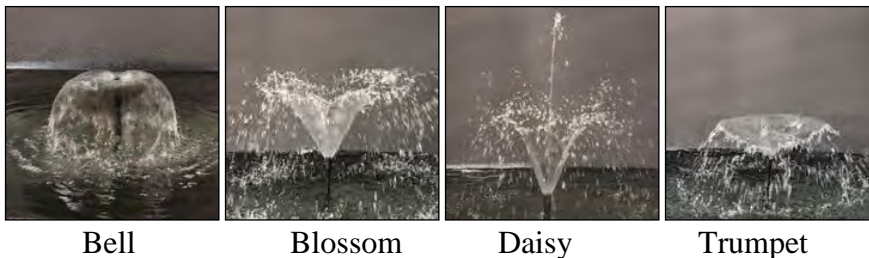

Bell Blossom Daisy Trumpet

Earth Bottom Lake and Pond

The “engine” that drives everything within a body of water is the presence of oxygen in proper levels. A pond’s condition deteriorates when its bottom environment cannot support aquatic life. The bottom is where the most oxygen is consumed and the farthest from the surface where it is replenished. Without adequate oxygen at the bottom, beneficial bacteria do not break down the organic waste. This results in increased layers of sediment (muck) along the pond bottom. Simply put, without oxygen a pond cannot clean itself!

Aeration

Installing aeration to your pond or lake is the single most valuable water management and water maintenance strategy a person can implement. The movement of oxygenated water from the bottom up provides a long list of benefits to your water. Pond and lakes age – the older a body of water, the higher the organic muck load and the higher total oxygen demand (TOD). Aeration can stop and even reverse, the effects of aging. Oxygen is the “fuel for the engine” that drives all biological and chemical process in your pond.

Beneficial Bacteria

Adding bacteria on a regular basis will improve water quality and clarity, reduce odors, improve oxygen levels and create a better environment for fish and other aquatic life. Combining aeration with additional bacteria is a proven method of reversing the aging process mentioned above. Supplementing your pond with natural bacteria to help reduce sludge build-up is a widely used practice

Weed and Algae Controls

There are wide variety of treatment product available to safely control aquatic weeds and algae in lakes and ponds. The use of these products is a good short term solution to a problem, however, to gain long term control you should look at the overall ecosystem and determine the source of the problem. Often aeration and/or the use of bacteria will greatly improve the system.

Aeration Kits for Shallow Ponds

For ponds 7’ deep or less, these linear powered aeration systems are a great choice. Choose from either single or double diffuser system. Single diffuser is ideal for round or regular shaped ponds. Use the dual diffuser system for long and narrow or irregular shaped ponds.

- Extremely energy efficient
- Very quiet operation
- Long lasting, oil free design
- Weather resistant enclosures – can be used outdoors, for maximum longevity use additional protection from elements
- Includes self weighted diffuser for easy installation
- Includes quick sink tubing for easy installation



PA6SWN – single diffuser – 50’ ½” quick sink tubing – aerates up to 3/8 acre - \$599.99

PA8SWN – dual diffusers - 100’ ½” quick sink tubing – aerates up to 3/4 acre - \$889.99



Easy Pro PA34 Aeration System

¼ hp Stratus SRC Gen 2 compressor with 2 year warranty. Outlet assembly has pressure relief. Kit includes 100’ of 3/8” weighted tubing, one rubber membrane diffuser assembly, and compressor. Low operation costs. Requires weather protection for compressor. \$1013.99



The deeper the air diffuser is located, the more “boiling action” it will create and a larger area will be aerated. Single diffuser best for round ponds.

- For ponds 5’-8’ deep – will aerate up to ¼ acre
- For ponds 8’-12’ deep – will aerate up to ½ acre
- For ponds 12’-16’ deep – will aerate up to 1 acre

Easy Pro PA34-2 Aeration System

¼ hp Stratus SRC Gen 2 compressor with 2 year warranty. Kit include 2 rubber membrane diffuser and compressor. Tubing sold separately (order 3/8” tubing). Ideal for aerating long narrow pond or 2 small ponds with single compressor. Requires weather protection for compressor. \$1098.99 with cabinet \$2092.99



Roto-Molded Cabinet

Economical alternative to steel cabinet. Ran color blends well into existing landscape. Built in louvers allow fresh air into cabinet. Cooling fan is recommended for large compressors or in hot locations. Cabinet sold separately \$239.99 without fan \$299.99 with 115v fan

Algae Defense Gallon	\$89.99
Ultra Pond Weed Defense Quart	\$89.99
Ultra Pond Weed Defense Gallon	\$149.99
Shoreline Defense Quart	\$89.99
Shoreline Defense Gallon	\$149.99



Lake & Pond Vive

The natural, biological way to revive your pond. This special blend of bacteria is designed to reduce sludge buildup, eliminate pond odors, improve water clarity, reduce oxygen demand, eliminate excess nutrients. Pre-measured water soluble packets you just toss in. 2 packets treats ¼ acre new pond for 2 weeks, use 3 packets every 2 weeks for older ponds.
10 lb pail (20 packets) \$154.99
5 lb pail (10 packets) \$89.99



Barley Pellets

100% natural from concentrated barley straw. Safe for use with aquatic life and pets. Apply every 6-8 weeks. 40 lb bag treats 1/3 acre \$69.99

Pond Accents

Faux Stump

Great for hiding outdoor electrical outlets by the pond or just in the landscape. Can also be used as a decorative accent that is also a seat.

15" diameter, 18.5" height – hollow inside

\$129.99

Faux Stone Propane Cover \$219.99 (not shown)



Faux Driftwood

Ideal for concealing hard to hide water feature component such as skimmer openings and waterfall weirs. Place anywhere in the landscape as a decorative accent.

32.5"x10"x7.25" \$79.99

36.25"x10.75"x8" \$99.99



Faux Fish Cave

Protect your pond fish from pesky predators. The Aquascape Faux Log Fish Cave provides pond fish, such as goldfish and koi, shelter from predators such as herons. The natural-looking faux wood design blends well into any setting and can be used for indoor or outdoor use. Add to existing ponds, new ponds, or use as a decorative accent in the garden. The heavy-duty, poly-resin construction is built to last and stand up to the elements. \$132.99

DekoRRa Faux Rocks

Artificial rocks made with textured material that can be used to hide electrical outlets or just as accent boulders in the landscape without the weight of real rock. Flange around the edge allows you to stake it into ground.



Model 106
19"x14"x12"
\$129.99



Model 109
30"x23"x18"
\$189.99



Creatures, Critters and Art

We have a rotating selection of frogs, turtles, humans, fountains and more for you to add to the landscape. Come in to check them out.



Directions

157 Central Street
Rowley, MA 01969

From the South

Route 95 North to Exit 78 (formerly Exit 54). Take Route 133 East to the junction of Route 1. Turn left at Route 1 heading north. Continue 2 miles to 2nd traffic light. Take right onto Central Street. We are 1 ½ miles on the left.

From the North

Route 95 south to Exit 78 (formerly Exit 54). Follow directions above. Or take Route 1 South. Approximately 7 miles south of the Newburyport rotary, turn left at the traffic light. (This is after you pass the blinking lights at The Governor's Academy.) We are 1 ½ miles on the left.

From the West

Route 128 to Route 95 North. Follow the directions from the South above

*We also offer a full line of annuals, perennials, dwarf shrubs,
ornamental grasses, hardy mums and ornamental kale for
landscaping around your pond.*

*Open Seasonally
Hours vary by season*

*www.countrygardens-rowley.com
email: support@countrygardens-rowley.com*