



2024





**It is important to keep in mind that water gardening is rapidly growing. New trends and products are introduced all the time. In order to keep you updated when you can't make it in we have 3 electronic ways to get information from us:**

Our webpage & Online Store

[www.countrygardens-rowley.com](http://www.countrygardens-rowley.com)

**Our email newsletter "Ripples"**

sign up from the link on our web page or at the cash register

**Country Gardens Water Garden Specialist Facebook Page.**

Link is on our web page



Web Page



Facebook Page

*New products are coming in all the time so be sure to stop by and see our complete water gardening line.*

*We also offer the plumbing supplies to get your pond started and keep it running.*

*All prices in this catalog are based on current market conditions and are subject to change.*

# ***Table of Contents***

|  |                |
|--|----------------|
| <b>Cross Section of a Pond</b>         | <b>Page 5</b>  |
| <b>Flexible Liners</b>                 | <b>Page 6</b>  |
| <b>Underlay</b>                        | <b>Page 7</b>  |
| <b>Installing a Flexible Liner</b>     | <b>Page 8</b>  |
| <b>Preformed Pools</b>                 | <b>Page 9</b>  |
| <b>Installing a Preformed Pond</b>     | <b>Page 10</b> |
| <b>Patio Ponds</b>                     | <b>Page 11</b> |
| <b>Pumps</b>                           | <b>Page 12</b> |
| <b>Submersible Pumps</b>               | <b>Page 13</b> |
| <b>Check Valves</b>                    | <b>Page 14</b> |
| <b>Tubing</b>                          | <b>Page 18</b> |
| <b>External Pumps</b>                  | <b>Page 18</b> |
| <b>Filters</b>                         |                |
| <b>Submersible</b>                     | <b>Page 19</b> |
| <b>All In One</b>                      | <b>Page 19</b> |
| <b>Replacement Media</b>               | <b>Page 20</b> |
| <b>Pressurized Filters</b>             | <b>Page 21</b> |
| <b>Eazy Pod &amp; K+</b>               | <b>Page 22</b> |
| <b>Cetus Sleeve &amp; Nexus</b>        | <b>Page 23</b> |
| <b>Filters as part of waterfall</b>    | <b>Page 24</b> |
| <b>Skimmers</b>                        | <b>Page 26</b> |
| <b>Auto Fill Valve</b>                 | <b>Page 27</b> |
| <b>Pond Free Systems</b>               |                |
| <b>Vaults</b>                          | <b>Page 28</b> |
| <b>Reservoir cubes</b>                 | <b>Page 29</b> |
| <b>Waterfall Weir</b>                  | <b>Page 29</b> |
| <b>Ultra Violet Light</b>              | <b>Page 31</b> |
| <b>Underwater Lights</b>               | <b>Page 33</b> |
| <b>Disappearing Fountains</b>          | <b>Page 35</b> |
| <b>Vases &amp; Basalt Rock Columns</b> | <b>Page 36</b> |
| <b>GFRC Bubbling Rocks</b>             | <b>Page 37</b> |
| <b>Twister &amp; Bowl Fountains</b>    | <b>Page 38</b> |
| <b>Faux Urns, Spheres &amp; Walls</b>  | <b>Page 39</b> |
| <b>The Balanced Pond</b>               | <b>Page 40</b> |
| <b>The Nitrogen Cycle</b>              | <b>Page 41</b> |
| <b>Water Lilies</b>                    | <b>Page 42</b> |
| <b>Lotus</b>                           | <b>Page 43</b> |
| <b>Hardy Marginal Plants</b>           | <b>Page 44</b> |
| <b>Tropical Marginal Plants</b>        | <b>Page 45</b> |



Web Page

*continued on next page*

[www.countrygardens-rowley.com](http://www.countrygardens-rowley.com)

|  |                |
|--|----------------|
| <b>Floating Plants</b>                         | <b>Page 46</b> |
| <b>Submerged Plants</b>                        | <b>Page 46</b> |
| <b>Fish</b>                                    | <b>Page 47</b> |
| <b>Fish Food</b>                               | <b>Page 49</b> |
| <b>Water Clarity &amp; Fish Care</b>           |                |
| <b>Water Conditioners</b>                      | <b>Page 51</b> |
| <b>Phosphate Control &amp; Carbon</b>          | <b>Page 52</b> |
| <b>Algae Control</b>                           | <b>Page 53</b> |
| <b>Barley</b>                                  | <b>Page 54</b> |
| <b>Flocculants</b>                             | <b>Page 55</b> |
| <b>Biological Bacteria, Liquid</b>             | <b>Page 56</b> |
| <b>Biological Bacteria, Dry</b>                | <b>Page 57</b> |
| <b>Aqua Defend</b>                             | <b>Page 58</b> |
| <b>Cool Water Bacteria</b>                     | <b>Page 58</b> |
| <b>Fish Medication</b>                         | <b>Page 59</b> |
| <b>Water Enhancements for Fish</b>             | <b>Page 60</b> |
| <b>Accessories</b>                             |                |
| <b>Test Kits</b>                               | <b>Page 61</b> |
| <b>Plant Supplies</b>                          | <b>Page 61</b> |
| <b>Fish &amp; Pond Nets</b>                    | <b>Page 62</b> |
| <b>Winter/Fall Supplies</b>                    | <b>Page 63</b> |
| <b>Pond Maintenance</b>                        | <b>Page 67</b> |
| <b>Pond Construction</b>                       | <b>Page 67</b> |
| <b>Diverters &amp; Fountains</b>               | <b>Page 68</b> |
| <b>Water Movement</b>                          | <b>Page 69</b> |
| <b>Rain Harvesting</b>                         | <b>Page 70</b> |
| <b>Earth Bottom Pond &amp; Lake Treatments</b> | <b>Page 71</b> |
| <b>Pond Accents</b>                            | <b>Page 73</b> |
| <b>Directions</b>                              | <b>Page 74</b> |

**Shop Online**

**[www.countrygardens-rowley.com](http://www.countrygardens-rowley.com)**



## ***Cross Section of a Pond***

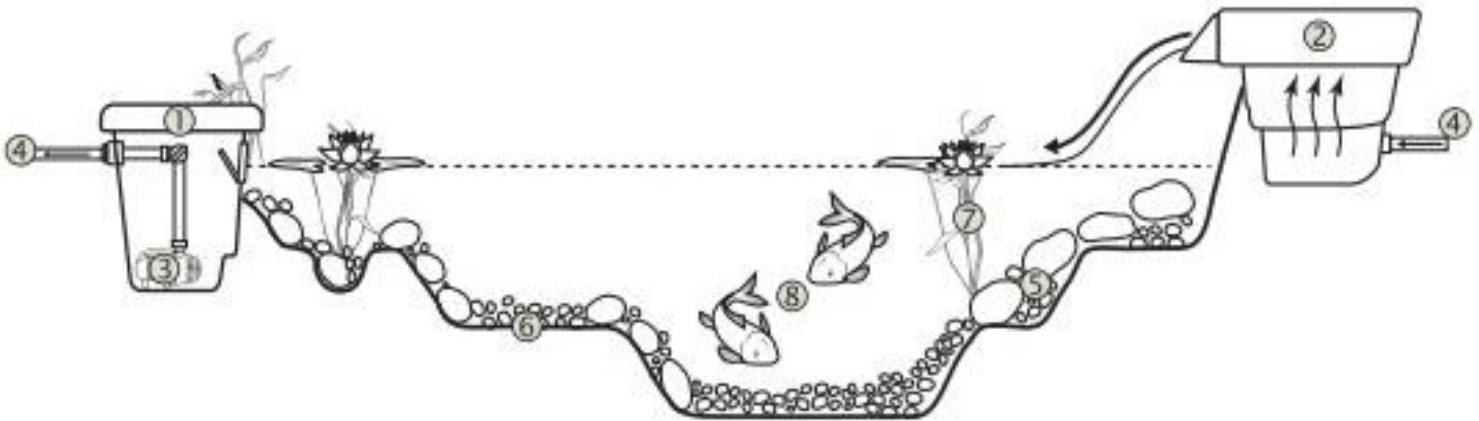

1. **Pond Skimmer** – Pre-filters water and houses pump, collects debris and reduces maintenance. A filter pad or set of brushes collect debris before it reaches the pump. Regular cleaning is necessary to enable water flow. Size is determined by flow of pump and surface area of the pond. See pages 26-27
2. **Biofalls Filter** – Provides surface area for beneficial bacteria to colonize and remove excess nutrients from the water. Fed by the pump, the water flows up through filter media and gravity fed back to the pond. Can be set back from the pond and flow through streambed. Annually cleaning in either the spring or the late fall is typical. See pages 23-25
3. **Pond Pump** – Pumps water from the pond skimmer to the biofalls filter. The size of the pump can be determined on page 12. Often a check valve is used to prevent water from flowing back into the pond from the biofalls when the pump is turned off. Pump options on pages 13-18
4. **Pipe** – Directs water from the skimmer to the biofalls filter. The size of the pipe should be determined by the flow rate of the pump, see page 18. Ideally all water should drain from the pipe in the winter to prevent freezing and cracking. If installation is such that water does not automatically drain from the pipe, it should be blown out.
5. **Rocks and Gravel** – Naturalizes the pond and provides surface area for beneficial bacteria to grow and break down excess nutrients. Can help to protect the liner, however, the use of too much rock and gravel will trap organics and make maintenance more difficult. Excess organic material can result in poor water quality and poor fish health. Regular cleaning and the use of beneficial bacteria will help to minimize these effects.
6. **Pond Liner and Underlay** – Forms the pond's foundation for containing the water and allowing for gases to escape from beneath the pond. A fish safe 45 mil EPDM rubber is the most common material used. The fabric underlay will help prevent sharp objects (rock, roots) from penetrating the rubber liner. Underlay can also be used between the liner and larger rocks inside the pond for extra protection. See pages 6-7 for sizes.
7. **Plants** – Filter pond water, thereby minimizing maintenance and improving water conditions. Use nutrients in the pond helping to starve out unwanted algae. Provide fish with shade and shelter from some predators. Floating, marginal and deep water plants can combine for a natural setting in the pond, see pages 41-47.
8. **Fish** – Provide nutrients for pond plants. Fish are the life of the pond and provide a great way to interact with it. Koi and comets are the most colorful pond fish – each suited to a particular size and style of pond, see pages 48-49.

***Options such as UV lights, Pressure Filters, Underwater Lights, Bubbling Rocks, Vases and more available***

# Flexible Liners

Although a depth of 30" is ideal for over-wintering fish in this area, an 18"-24" deep pond makes an excellent fish pond and water garden. Finished sizes for 24" deep ponds made with a flexible liner may be estimated simply by subtracting 7' from each liner dimension. This will include a 1 foot stone shelf all around the pond to hide the liner and 6" of buffer liner around the entire pond.

## EPDM Pool Liners

EPDM is a synthetic rubber that offers the ideal combination of durability and affordability for lining garden ponds. EPDM rubber (Ethylene Propylene Diene Monomer) has long been known for its outstanding weathering properties and it has been exposed to direct sunlight over long periods of time. It will withstand permanently ponded water.

| Liner Size | (24" depth)<br>Finished Pond | *Max<br>Gallons | Price     |
|------------|------------------------------|-----------------|-----------|
| 10'x10'    | 3'x3'                        | 134             | \$170     |
| 10'x15'    | 3'x8'                        | 359             | \$255     |
| 10'x20'    | 3'x13'                       | 583             | \$340     |
| 10'x25'    | 3'x18'                       | 807             | \$425     |
| 10'x30'    | 3'x23'                       | 1032            | \$510     |
| 10'x50'    | 3'x43'                       | 1930            | \$850     |
| 15'x15'    | 8'x8'                        | 957             | \$382.50  |
| 15'x20'    | 8'x13'                       | 1555            | \$510     |
| 15'x25'    | 8'x18'                       | 2154            | \$637.50  |
| 15'x30'    | 8'x23'                       | 2752            | \$765     |
| 15'x50'    | 8'x43'                       | 5146            | \$1275    |
| 20'x20'    | 13'x13'                      | 2528            | \$680     |
| 20'x25'    | 13'x18'                      | 3500            | \$850     |
| 20'x30'    | 13'x23'                      | 4473            | \$1020    |
| 20'x40'    | 13'x33'                      | 6417            | \$1360    |
| 20'x50'    | 13'x47'                      | 9140            | \$1700    |
| 25'x25'    | 18'x18'                      | 4847            | \$1062.50 |
| 25'x30'    | 18'x23'                      | 6193            | \$1275    |
| 25'x50'    | 18'x43'                      | 11,579          | \$2125    |
| 30'x30'    | 23'x23'                      | 7914            | \$1530    |
| 30'x50'    | 23'x43'                      | 14,795          | \$2550    |

Liner cut in 5' increments  
Ask about additional sizes  
available \$1.70 per square foot



### Elevate PondGard

- 45 mil
- Easily installed
- Flexible for creative designs
- Specially formulated for water gardening projects
- Safe for fish and plant life
- Contains no migrating plasticizers - which means no cracking or splitting
- Resistance to UV exposure, ozone, frost, snow and extreme temperatures

\*Max gallons is if a perfect rectangle.

### **Waterfall Tips**

- Be sure to overlap the water fall liner into the pond
- Provide plenty of support along the walls of the waterfall
- Be sure the liner is beneath all rocks in the waterfall
- Use a combination of sizes of stone for a more natural looking waterfall.

| <u>Waterfall Liner</u> | <u>EPDM Price</u> |
|------------------------|-------------------|
| 5'x5'                  | \$42.50           |
| 5'x10'                 | \$85              |
| 5'x15'                 | \$127.50          |
| 5'x20'                 | \$170             |
| 5'x25'                 | \$212.50          |
| 5'x30'                 | \$255             |
| 5'x35'                 | \$297.50          |
| 5'x40'                 | \$340             |
| 5'x45'                 | \$382.50          |
| 5'x50'                 | \$425             |

**Liner Repair Kit - \$36.99**

Patch kit from Firestone includes two 6"x6" patches, a 2 ounce bottle of Quick Prime, roller, scrubber pad, disposable gloves and instructions.



**Liner Underlay**

Liner Underlay will help prevent damage to pool liners by rocks and sharp stones. It is a thick non-woven polyester that is ideal for protecting synthetic rubber pond liners from abuse.

| <u>Size</u> | <u>Price</u> | <u>Size</u> | <u>Price</u> |
|-------------|--------------|-------------|--------------|
| 5'x5'       | \$11.25      | 10'x10'     | \$45         |
| 5'x10'      | \$22.50      | 10'x15'     | \$67.50      |
| 5'x15'      | \$33.75      | 10'x20'     | \$90         |
| 5'x20'      | \$45.00      | 10'x25'     | \$112.50     |
| 5'x25'      | \$56.25      | 10'x30'     | \$135        |
| 5'x30'      | \$67.50      | 10'x35'     | \$157.50     |
| 5'x35'      | \$78.75      | 10'x40'     | \$180        |
| 5'x40'      | \$90.00      | 10'x45'     | \$202.50     |
| 5'x45'      | \$101.25     | 10'x50'     | \$225        |

*Protect your  
liner for just  
\$0.45 per  
square foot*

*Full Roll Discounts*  
**5'x360' \$729**  
**10'x360' \$1458**



| <u>To figure your liner size</u> |       |       |                   |       |       |
|----------------------------------|-------|-------|-------------------|-------|-------|
| Pond Length                      | 13'   | _____ | Pond Width        | 8'    | _____ |
| Depth x 2                        | 4'    | _____ | Depth x 2         | 4'    | _____ |
| Stone Shelf Width                | 2'    | 2     | Stone Shelf Width | 2'    | 2     |
| Stone Shelf Depth                | 1'    | 1     | Stone Shelf Depth | 1'    | 1     |
|                                  | ----- | ----- |                   | ----- | ----- |
| Liner Length                     | 20'   | _____ | Liner Width       | 15'   | _____ |

*Must be in 5' increments to order liner*

## Installing a Flexible Liner

1. Lay out desired pool shape with garden hose or other flexible material.
2. Excavate pool to desired depth. Be sure to include a stone shelf around the perimeter large enough to accommodate the size stones you have chosen. Side walls should not exceed a 33 degree slope. Remove all sharp objects from excavation. Add 2 to 3 inches of sand or a liner underlay to cushion the bottom and side walls. Be sure the pond is level across the top.
3. Lay the liner in the excavated site, trying to remove the wrinkles as you go. Once the water is in, the weight of the water will prevent you from smoothing out the liner. Begin building your stone perimeter and adding stone on the bottom of the pond if desired. Do not trim away any excess liner until the job is finished.
4. Any waterfall construction or plumbing features is better done before water is added to the pond. If your waterfall is made from flexible liner, be sure to leave a 1'-2' overlap down into the pond to help prevent leaks. Plumbing that requires through the liner insertion should be sealed to the liner and left to dry before coming in contact with the water.
5. When the rocks, waterfall and plumbing are in place you may begin filling with water and finishing around the pond.

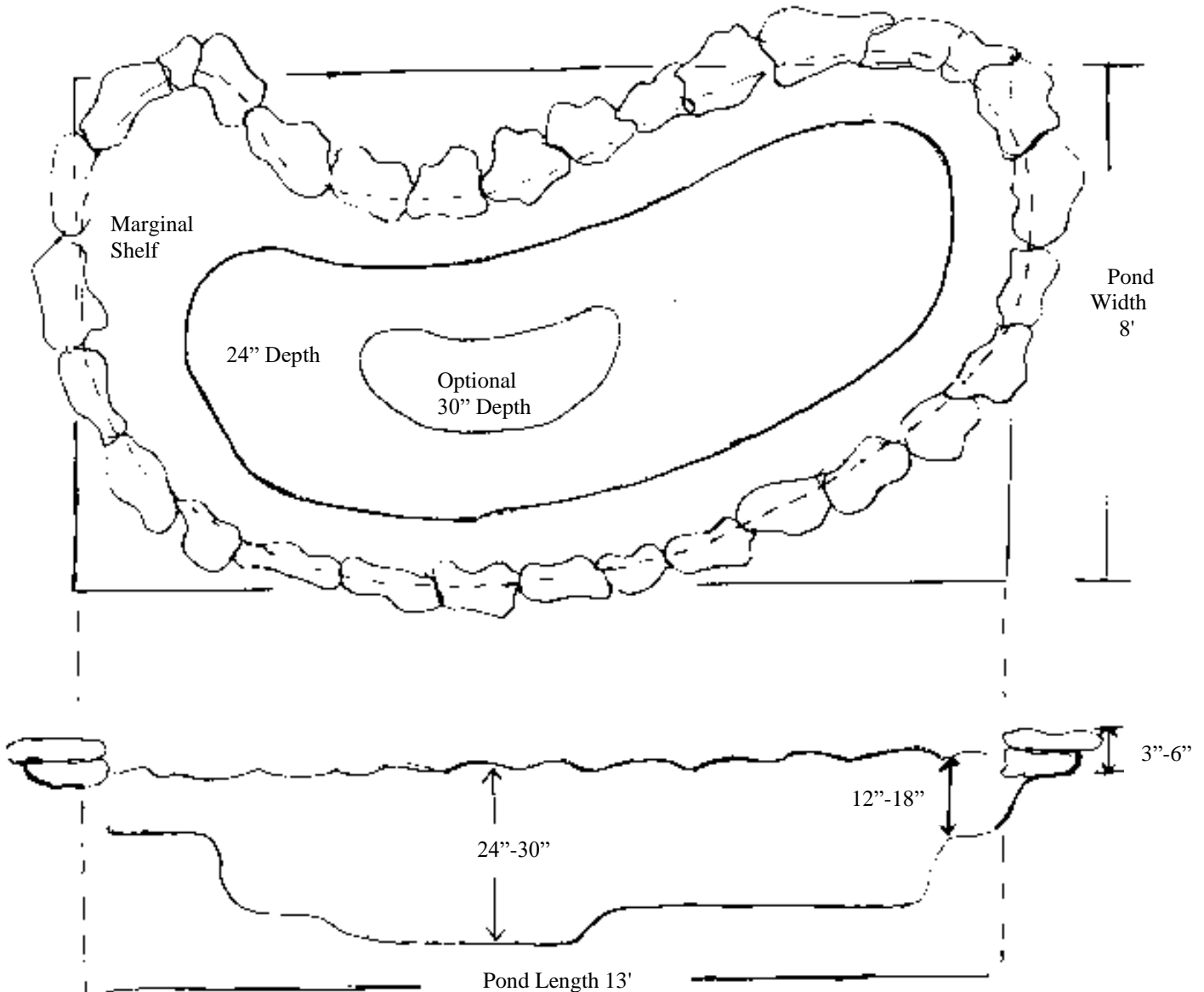



# Preformed Ponds

## Preformed Polyethylene Ponds

Windermere  
133 gallons  
74" x 51" x 22"  
\$191.99



Ennerdale  
91 gallons  
67" x 48" x 18"  
\$169.99

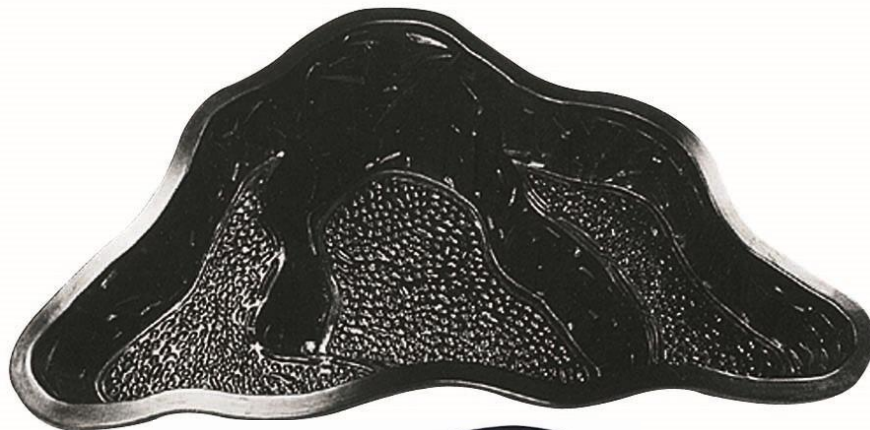

Coquetdale  
31 gallons  
44" x 32" x 13" -  
\$94.99



Rectangle  
75 gallons  
31" x 46" x 16"  
\$189.99



Country Gardens  
(978)948-2124

Wine Barrel  
35 gallons  
29" diameter, 13.5" depth  
\$51.99



Whiskey Barrel Liner  
20 gallons  
26" diameter, 15" depth - \$75.99  
With spillway \$79.99



## Steps for Installing a Preformed Pond

1. Select the prefabricated shell.
2. Measure and outline the excavation.
3. Excavate the site.
4. Line the bottom with sand.
5. Level the bottom.
6. Install and fill the shell and backfill around the sides with soil, being sure the pond stays level.
7. Add edging or coping.

Use a garden hose to map out the outline of your water garden before digging. Make the excavation 2 inches wider than the outline.

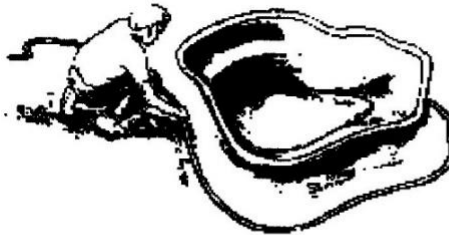

Use a spirit level to check that the sand covered bottom is level. Check again after the pond has been set in to be sure that it is level.

Simultaneously fill the pond while backfilling the outside to keep the pond from shifting.



# Patio Ponds

## Aquatic Patio Ponds

Aquascape Aquatic Patio Ponds make it simple to have a complete water garden in almost any setting. Creating a beautifully planted water bowl or container water garden has never been easier. Aquascape Aquatic Patio Ponds have all the natural beauty of real rock with the added durability and light weight of fiberglass. Can be used indoors or outdoors.

Round 24" - \$429.99

Round 32" - \$499.99



Poly-resin fountain work

Great with patio ponds.

Pouring Bamboo 89.99

Deer Scarer \$79.99

Pouring Three Tiered \$79.99

Lazy Frog on Lily Pad \$79.99

\*\*see page 74 for more options



## Pump and Filter Combo



Complete solution for small to medium-size container water gardens or any containers with stagnant or non-moving water. Magnetically driven or mag drive motor technology is simple and easy to maintain. Extremely energy-efficient. Durable pre-filter water intake design prevents clogging and reduces pump maintenance. \$36.99

## Patio Pond Maintenance Tabs

help to provide clean, clear, and healthy water conditions, significantly reducing maintenance required in container water gardens. Our Patio Pond Maintenance Tabs contains 8 pure strains of beneficial bacteria to help optimize the water quality. 1 tab treats 100 gallons  
36 tabs \$14.99



## Aquatic Patio Pond Kit

Add the beauty of water to your garden, deck, patio or balcony. Kit includes 16" Square Textured Gray Slate Patio Pond, Pouring Bamboo Fountain and Pump (plants sold separately) \$199.99

## AquaGarden Mini Pond Kit

Simple and easy to add the sights and sounds of a water garden to any location. If desired, a few small fish and a wide variety of plants can be added to create your very own one-of-a-kind aquatic paradise. A durable injection-molded construction features a rippled, textured finish and is lightweight and durable for a long-lasting, easy-to-install design. The kit includes all media and substrate needed, including expanded clay grow/biological media and decorative gravel for both the waterfall and pond.

23.5" diameter and 9 7/8" tall. \$179.99 Stand sold separately 16" tall - \$89.99

Plant Light sold separately \$89.99

Tabletop version \$89.99 (11.5" diameter x 5" tall container)





# Pumps

## MOST IMPORTANT NUMBER TO KNOW ABOUT YOUR POND IS THE NUMBER OF GALLONS

*To find the number of gallons in a pond  
(Measurements should be in feet. There are 7.48 gallons of water per cubic foot.)*

*For a rectangle: Length x Width x Depth x 7.48 = Gallons in pond  
For irregular shapes: use the rectangle measurement and multiply by 80%  
For a Circle:  $3.14 \times (1/2 \text{ diameter} \times 1/2 \text{ diameter}) \times \text{depth} \times 7.48 = \text{Gallons in pond}$*

### Pump Sizing

1. You should circulate 1/2 the volume of the pond in 1 hour. For every 1" of waterfall width you will need approximately 100 GPH of water
2. Take into consideration the vertical lift your pump will push the water to get to the top of the waterfall.
3. Every 10' of horizontal movement is equal to 1 vertical foot. Place your pump as far from the water return as possible to maximize circulation.
4. Keep in mind limitations of skimmers, filters, and tubing sizes.
5. Use the pump that fits the largest of the above equations but operates in its optimal range on curve as indicated to by gray shading.

**Example** – You have a 1500 gallon pond with a waterfall that is 36" wide. The vertical rise is 3' from the pond to the top of the waterfall, but you are running it through 20' of tubing.

**Answer** - The 1500 gallon pond would use a pump that is 750 gallons, but to get a nice flowing waterfall you will need a pump that puts out 3600 gph (36"x 100 gph) at a vertical height of 5' (3' vertical plus 2' for the horizontal of 20'). You could choose the Easy Pro TH250 pump or the Atlantic TT5000 to satisfy the flow rate - \*\*\*however, the Th250 requires 10' of head pressure to operate efficiently so the TT5000 is the better choice. (see charts on pages 16-17)

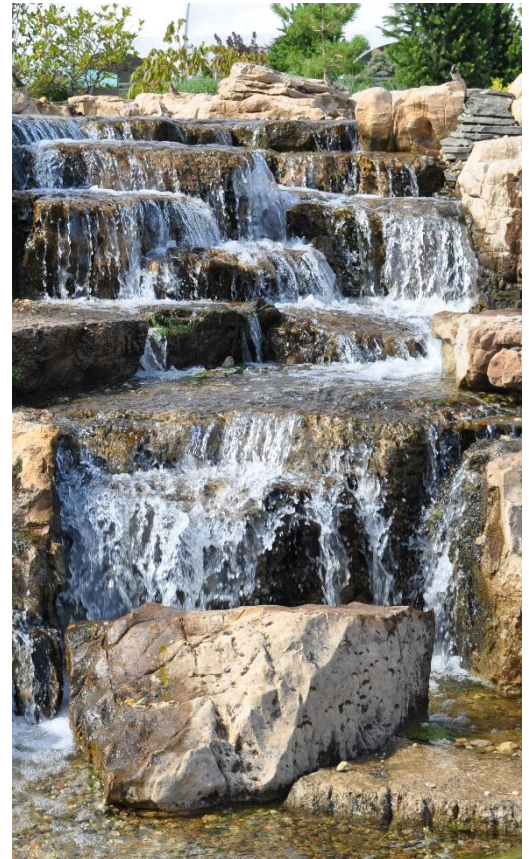

### ***Why should I circulate my water?***

#### ***1. To add oxygen to the pond***

As temperatures rise, dissolved oxygen levels in water decrease. During the summer months, plants alone cannot supply fish, especially large fish, with enough oxygen in a closed system such as a water garden. Other organisms, such as the nitrifying bacteria in your biological filter, also will need added oxygen. A waterfall, statuary or fountain will add oxygen to the water each time the water returning to the pond breaks the surface of the pond.

#### ***2. To reduce stagnant water***

Stagnant water is a breeding ground for mosquito larvae. Mosquitoes will not lay eggs in moving water, however, if you are not circulating your pond water, they will breed. Also, motionless water can create a foul odor and algae usually develops quicker.



**Winter Tip**

Do not leave your pump in a skimmer box during the winter months. Disconnect it, clean it, drain it, and store it for winter indoors.

**Submersible Pumps**

**Atlantic Pumps**

***Tidal Wave MD Series***

These magnetic induction pumps are perfect choice for small water features with low head heights. Hefty and heavy duty, equipped with removable pre-filters, oversize ceramic shafts, replaceable impeller assemblies. Great energy efficiency and a five year warranty. Oversized male threaded inlet and outlet for less restriction and greater flow. Rotating volute provides maximum adaptability for any installation. Quarter twist volute provides access to the impeller assembly without the use of tools. Large, stable base is removable. Removable pre-filter provides increased surface area and reduces maintenance. Tapered outlet fittings accept a wide array of tubing sizes. MD1000-MD2000 include a 1 1/2" adapter for use with the Triton Check Valve and Fountain Basin Plumbing Kits. 20' power cord.

|        | <u>Pump</u> | <u>Replacement Impeller</u> | <u>Replacement Intake Kit</u> |
|--------|-------------|-----------------------------|-------------------------------|
| MD 250 | \$89.99     | \$20.99                     | \$24.99                       |
| MD350  | \$94.99     | \$23.99                     | \$24.99                       |
| MD550  | \$104.99    | \$24.99                     | \$24.99                       |
| MD750  | \$119.99    | \$25.99                     | \$24.99                       |
| MD1000 | \$209.99    | \$85.99                     | \$19.99                       |
| MD1250 | \$254.99    | \$107.99                    | \$19.99                       |
| MD1500 | \$297.99    | \$134.99                    | \$21.99                       |



***TidalWave 3 Series***

The next generation of ultra-high efficiency asynchronous pumps, with more water moved per watt than ever before. Remarkably compact to fit in the tightest spaces. Specifically designed to be clog resistant and hard water tolerant. Large threaded inlet and outlet for less restriction and greater flows. Quarter turn volute provides access to impeller without the use of tools. Heavy duty pre-filter locks in place. Large openings and increased surface area resist clogging. Three van hybrid impeller improves flows and passes solids easily. 20' power cord and 3 year warranty.

|        | <u>Pump</u> | <u>Replacement Impeller</u> | <u>Replacement Intake Kit</u> |
|--------|-------------|-----------------------------|-------------------------------|
| TT1500 | \$253.99    | \$62.99                     | \$20.99                       |
| TT2000 | \$281.99    | \$63.99                     | \$20.99                       |
| TT3000 | \$337.99    | \$64.99                     | \$20.99                       |
| TT4000 | \$478.99    | \$100.99                    | \$24.99                       |
| TT5000 | \$534.99    | \$104.99                    | \$24.99                       |
| TT6000 | \$590.99    | \$107.99                    | \$24.99                       |
| TT7500 | \$759.99    | \$119.99                    | \$34.99                       |



**Hints for keeping your pumps running smoothly**

1. Use a pre-filter on inlet to catch debris before it gets into the impeller.
2. Clean around the impeller area when you clean the pre-filter. This will alert you to any problems with debris going through the pre-filter and into the pump.
3. Do not run your pump out of the water. Most submersible pumps are water cooled, and overheating them by running them without water may damage the pump.
4. Do not lift your pump in and out of the pond using the electrical cable. Continuous strain on this cable may cause short-circuiting or could break the seal around it.
5. Do not break the seals on the pump, this will void the warranty. Do not remove or alter the electrical cord in any way as this will also void the warranty.

***Be sure to keep your receipt and box your pump came in. In the event that the pump malfunctions within the warranty period, you will need these.***

Country Gardens  
(978)948-2124



## Easy Pro Pumps

### Stainless Steel TH Series

A great choice for ponds, waterfalls, fountains and similar applications.

Compact design is ideal for use in skimmers. Rugged motor – designed for long life, continuous duty operation; motor housing is corrosion-resistant stainless steel. Low maintenance- pump casing is made from abrasion-resistant, fiber reinforced plastic for maximum life. Vortex design prevents clogging. Built-in overload and overheat motor protections.

2" female threaded outlet. 2 year warranty.

|       |          |          |
|-------|----------|----------|
| TH150 | 3100 GPH | \$449.99 |
| TH250 | 4100 GPH | \$549.99 |
| TH400 | 5100 GPH | \$632.99 |
| TH750 | 6000 GPH | \$771.99 |

Optional screen for bottom fits models 2009 and newer \$23.99



### Check Valves

Prevents water loss when pump is shut off

. (Remember to disconnect in the winter)

Easy Pro 2" MPT x 1 1/2" coupling \$79.99

Easy Pro 2" MPT x 2" union \$79.99

Atlantic Universal \$79.99

Aquascape Dual Union \$75.99

## Rush Mag Drive Pumps

These pumps are typically used on fountains and small ponds. Can be use both submersible and out-of-water. Built in flow control, magnetic driven impeller, energy efficient and quiet. Pump body is heat and stress resistant molded plastic. Thermally protected. 3 year warranty.

|        |          |
|--------|----------|
| XR350  | \$114.99 |
| XR750  | \$134.99 |
| XR1200 | \$239.99 |



## PondBuilder Pumps

Magnetic drive pumps that are perfect choice for small water features with low head heights. These heavy duty pumps are equipped with a removable pre-filter, adjustable flow, replaceable ceramic shaft impellers, and a long heavy duty power cord. Operates in-line or submerged. 5 year warranty.

|          |          | <u>Cord length</u> | <u>Outlet</u> |
|----------|----------|--------------------|---------------|
| 120 GPH  | \$37.99  | 6'                 | 1/2"          |
| 180 GPH  | \$45.99  | 6'                 | 1/2"          |
| 290 GPH  | \$79.99  | 16'                | 3/4"          |
| 370 GPH  | \$89.99  | 16'                | 3/4"          |
| 530 GPH  | \$109.99 | 20'                | 3/4"          |
| 660 GPH  | \$129.99 | 20'                | 3/4"          |
| 800 GPH  | \$159.99 | 20'                | 3/4"          |
| 1110 GPH | \$179.99 | 20'                | 1"            |
| 1300 GPH | \$199.99 | 20'                | 1 1/4"        |



## Aquascape Pumps

### Aquaforce Series

Asynchronous, solids handling waterfall and filter pumps combine energy efficient performance, high flow rates, and ease of maintenance making this this pump the ideal choice for discriminating pond owners. The protective pre-filter cage allows pump to be placed directly into the pond. Able to pumps solids up to one quarter of an inch, making it ideal for use with eternal pressure filters. Oil-free design, plumbing adapter fittings included.

Aquaforce 1000 \$259.99                      Aquaforce 3600 \$379.99  
Aquaforce 1800 \$309.99                      Aquaforce 5200 \$479.99  
Aquaforce 2700 \$329.99



Limited 3 year warranty

### PL Series

Hydraulically dialed into the head pressure found in water garden applications. This helps ensure that the pump is performing in its ideal operating range, resulting in less vibration and wear and tear on the pump, ultimately resulting in longer life. Horizontal design. 20' power cord. 2" FPT outlet. 2 year limited warranty.

3PL \$669.99  
5PL \$889.99  
9PL \$1069.99



### SLD Adjustable Flow Series

Solids-handling, asynchronous motor technology provides superior reliability, reduced maintenance. The included Smart Control Receiver includes an integrated control panel and makes it easy to control your pump with the Aquascape Smart Control App, including flow adjustment and customized scheduling. An optional Universal Remote is available separately to allow wireless control without the use of a smartphone or tablet. Limited 3-year warranty.

2000-5000 gph \$769.99  
4000-7000 gph \$819.99  
5000-9000 gph \$1009.99



### Fountain and Statuary Pumps

Perfect for running smaller decorative fountains. Magnetically driven technology is simple and easy to maintain. Extremely energy efficient. Oil-free design prevents pond contamination. Includes flow control valve to create a customized water flow. 6' cord. 3 year limited warranty. 1/2" outlet

| <u>Pump</u> | <u>Price</u> | <u>Max Head Height</u> | <u>Watts</u> | <u>Impeller</u> |
|-------------|--------------|------------------------|--------------|-----------------|
| 70 GPH      | \$19.99      | 2'                     | 3.0          | \$4.99          |
| 90 GPH      | \$24.99      | 3'                     | 4.3          | \$4.99          |
| 180 GPH     | \$34.99      | 4'                     | 9.3          | \$4.99          |



## Tsurumi Pumps

Corrosion resistant pumps with durable resin molded parts that aid in longer pump life. Solids handling semi-vortex impeller. Eco-friendly operation. 2 year warranty.

2OM                      1 1/2" outlet                      20' power cord                      \$468.99  
2PU                      2" outlet                      20' power cord                      \$525.99  
3PN                      2" outlet                      20' power cord                      \$740.99  
4PN                      2" outlet                      20' power cord                      \$939.99  
8PN                      2" outlet                      20' power cord                      \$1085.99  
12PN                      3" outlet                      20' power cord                      \$1150.99





**Atlantic MD Series**

|        | AMPS | WATT | Gallons per hour at height |      |     |     |     | Inlet | Outlet | Price    |
|--------|------|------|----------------------------|------|-----|-----|-----|-------|--------|----------|
|        |      |      | 0'                         | 5'   | 10' | 15' | 20' |       |        |          |
| MD250  | .13  | 15   | 300                        |      |     |     |     | 1"    | 3/4"   | \$89.99  |
| MD350  | .22  | 25   | 370                        | 145  |     |     |     | 1"    | 3/4"   | \$94.99  |
| MD550  | .35  | 40   | 650                        | 385  |     |     |     | 1"    | 3/4"   | \$104.99 |
| MD750  | .44  | 50   | 790                        | 465  |     |     |     | 1"    | 3/4"   | \$119.99 |
| MD1000 | .79  | 90   | 1080                       | 785  | 275 |     |     | 1.5"  | 1"     | \$209.99 |
| MD1250 | 1.05 | 120  | 1330                       | 1040 | 580 |     |     | 1.5"  | 1"     | \$254.99 |
| MD1500 | 1.44 | 165  | 1560                       | 1255 | 780 |     |     | 1.5"  | 1"     | \$297.99 |

**Atlantic TidalWave 3 Series**

|        | AMPS | WATT | Gallons per hour at height |      |      |      |      |     | Outlet | Price    |
|--------|------|------|----------------------------|------|------|------|------|-----|--------|----------|
|        |      |      | 0'                         | 5'   | 10'  | 15'  | 20'  | 25' |        |          |
| TT1500 | .8   | 99   | 1640                       | 1060 | 350  |      |      |     | 1.5"   | \$253.99 |
| TT2000 | 1.1  | 132  | 2640                       | 1760 | 715  |      |      |     | 1.5"   | \$281.99 |
| TT3000 | 1.4  | 169  | 3000                       | 2180 | 1215 | 475  |      |     | 1.5"   | \$337.99 |
| TT4000 | 2    | 238  | 4490                       | 3330 | 1785 | 700  |      |     | 1.5"   | \$478.99 |
| TT5000 | 2.5  | 300  | 5150                       | 4255 | 3170 | 1615 | 395  |     | 2"     | \$534.99 |
| TT6000 | 2.7  | 317  | 6600                       | 4915 | 3065 | 1480 | 265  |     | 2"     | \$590.99 |
| TT7500 | 4.4  | 520  | 7650                       | 6300 | 4640 | 2860 | 1250 |     | 2"     | \$759.99 |

**Atlantic Variable Speed Controller**

Allows you to vary the output of pump . Wireless control via smartphone or remote.  
For use with Atlantic TT series pumps up to 800 watts.  
\$201.99



**Rush Mag Drive Pumps**

|        | Amps | Watts | Gallons per hour at height |      |      |     |     | Max  | Price    |
|--------|------|-------|----------------------------|------|------|-----|-----|------|----------|
|        |      |       | 0'                         | 2'   | 4'   | 6'  | 8'  |      |          |
| XR350  | .25  | 29    | 400                        | 350  | 220  | 100 |     | 7.5' | \$114.99 |
| XR750  | .52  | 60    | 800                        | 725  | 600  | 425 | 250 | 10'  | \$134.99 |
| XR1200 | .67  | 78    | 1320                       | 1200 | 1025 | 800 | 650 | 10'  | \$239.99 |

**Aquascape Aquaforce Series**

|      | AMPS | WATTS | Gallons per hour at height |      |      |      |      | Max   | Price    |
|------|------|-------|----------------------------|------|------|------|------|-------|----------|
|      |      |       | 1'                         | 5'   | 10'  | 15'  | 20'  |       |          |
| 1000 | .51  | 55    | 1070                       | 850  |      |      |      | 10'   | \$259.99 |
| 1800 | 1.33 | 160   | 2149                       | 1806 | 1320 | 260  |      | 16.5' | \$309.99 |
| 2700 | 1.25 | 147   | 2695                       | 2350 | 2000 |      |      | 14'   | \$329.99 |
| 3600 | 1.8  | 215   | 3868                       | 3613 | 3254 | 2100 |      | 18'   | \$379.99 |
| 5200 | 3    | 360   | 5284                       | 5000 | 4600 | 3500 | 1600 | 24'   | \$479.99 |



**Shading Indicates Best Head Height Range**

*Country Gardens  
(978)948-2124*

***Pond Builder Pumps***

|          | Amps | Watts | Gallons per hour at height |      |     |     |     | Max   | Price    |
|----------|------|-------|----------------------------|------|-----|-----|-----|-------|----------|
|          |      |       | 0'                         | 4'   | 8'  | 10' | 20' |       |          |
| 120 GPH  | .08  | 7     | 120                        |      |     |     |     | 2.6'  | \$37.99  |
| 180 GPH  | .12  | 9.5   | 180                        |      |     |     |     | 4.7'  | \$45.99  |
| 290 GPH  | .23  | 16    | 290                        | 195  |     |     |     | 5.95' | \$79.99  |
| 370 GPH  | .40  | 24    | 370                        | 225  |     |     |     | 7.6'  | \$89.99  |
| 530 GPH  | .55  | 33    | 530                        | 390  |     |     |     | 7.92' | \$109.99 |
| 660 GPH  | .73  | 43    | 660                        | 440  | 200 |     |     | 8.82' | \$129.99 |
| 800 GPH  | .80  | 58    | 798                        | 600  | 300 |     |     | 9.3'  | \$159.99 |
| 1110 GPH | .85  | 92    | 1110                       | 875  | 600 | 350 |     | 12.2' | \$179.99 |
| 1300 GPH | 1    | 110   | 1300                       | 1050 | 800 | 600 | 300 | 13.5' | \$199.99 |

***Mechanical Drive Pumps – Must have proper head pressure to operate efficiently.***

***Easy Pro Pumps***

|       | Amps    | HP  | Gallons per hour at height |      |      |      |      |      |     | Max | Price    |
|-------|---------|-----|----------------------------|------|------|------|------|------|-----|-----|----------|
|       |         |     | 1'                         | 5'   | 10'  | 15'  | 20'  | 25'  | 30' |     |          |
| TH150 | 2.6-3.1 | 1/4 | 3100                       | 2760 | 2100 | 1380 | 600  |      |     | 23' | \$449.99 |
| TH250 | 3.0-4.2 | 1/3 | 4100                       | 3900 | 3240 | 2580 | 1800 | 900  |     | 30' | \$547.99 |
| TH400 | 3.7-6.0 | 1/2 | 5100                       | 4980 | 4380 | 3600 | 2760 | 2040 |     | 36' | \$632.99 |
| TH750 | 6.0-9.9 | 1   | 6000                       | 5880 | 5460 | 4980 | 4380 | 3720 |     | 43' | \$771.99 |



***Tsurumi Pumps***

|     | Amps | HP  | Gallons per hour at height |      |      |      |      |      | Max | Price     |
|-----|------|-----|----------------------------|------|------|------|------|------|-----|-----------|
|     |      |     | 5'                         | 10'  | 15'  | 20'  | 25'  | 30'  |     |           |
| 2OM | 3.2  | 1/5 | 2430                       | 2010 | 1500 | 960  |      |      | 23' | \$468.99  |
| 2PU | 3.1  | 1/5 | 2880                       | 2130 | 1200 |      |      |      | 17' | \$525.99  |
| 3PN | 4.6  | 1/3 | 3630                       | 2760 | 2400 | 1800 | 1080 |      | 30' | \$740.99  |
| 4PN | 5.8  | 1/2 | 4740                       | 4320 | 3700 | 3000 | 2400 | 1800 | 44' | \$939.99  |
| 8PN | 8.7  | 1   | 5520                       | 5400 | 5340 | 4800 | 4200 | 3600 | 56' | \$1085.99 |

***Aquascape PL Series***

|     | AMPS | WATTS | Gallons per hour at height |      |      |      |      | Max | Price     |
|-----|------|-------|----------------------------|------|------|------|------|-----|-----------|
|     |      |       | 1'                         | 5'   | 10'  | 15'  | 20'  |     |           |
| 3PL | 4.6  | 328   | 3300                       | 3000 | 1800 |      |      | 14' | \$669.99  |
| 5PL | 5.8  | 660   | 5100                       | 5000 | 4100 | 3150 | 1800 | 22' | \$889.99  |
| 9PL | 9.7  | 987   | 6900                       | 6800 | 6200 | 5400 | 4700 | 35' | \$1069.99 |

***Smart Control Plug***

*The Aquascape Smart Control Plug allows you to control and monitor outdoor electronics from your anywhere using your Smart phone or Tablet. Setup is quick and easy. The plug features three outlets so you can control three products simultaneously. Use dynamic scheduling to have products turn on automatically when you need them and get real-time energy consumption data for any electronic device to make informed decisions and save money. The astronomical timer allows the outlets to automatically turn on and off based on your location. The device also works with Alexa for easy voice control. Adequate wireless coverage is required (2.4 GHz supported). The Smart Plug is backed by a 3-year limited warranty to ensure year after year of reliable use. \$66.99*

### Proper Tubing Sizing

| To get (GPH) | Use tubing ID |
|--------------|---------------|
| 250          | 1/2"          |
| 700          | 3/4"          |
| 1000         | 1"            |
| 1500         | 1 1/4"        |
| 3000         | 1 1/2"        |
| 5000         | 2"            |
| 9000         | 3"            |



This chart indicates the recommended inner diameter of tubing for the maximum gph of the pump.

Sold in 5' increments.

#### Vinyl

1/4" - \$0.45 per foot  
3/8" - \$0.55 per foot  
1/2" - \$0.65 per foot

#### Vinyl

5/8" - \$0.95 per foot  
3/4" - \$1.60 per foot  
1" - \$2.10 per foot

#### Flex PVC

1 1/4" - \$2.99 per foot  
1 1/2" - \$2.99 per foot  
2" - \$3.79 per foot  
3" - \$7.39 per foot (*non-stock – must be ordered in 25' increments*)

Metric - 32 mm \$2.79 per foot    38mm \$2.79 per foot

## External Pumps

### PerformancePro Artesian Pumps

This line of pumps is the perfect choice for efficiency and reliability with the added convenience of safety and self-priming. Molded of corrosion-resistant polypropylene, Artesian pumps are ideal for applications in which the pump is positioned above the water. An easy-open Lexan lid provides ready access to the integral strainer pot's large basket. Pumps have 2" female NPT suction and discharge. Inexpensive to operate. Price includes 8' power cord with 115 volt plug. 3 year warranty

| Model     | HP  | Watts | Gallons per hour at height |      |      |      | Max | Price     |
|-----------|-----|-------|----------------------------|------|------|------|-----|-----------|
|           |     |       | 5'                         | 10'  | 15'  | 20'  |     |           |
| A2 1/8-39 | 1/8 | 198   | 3420                       | 2520 | 1140 |      | 16' | \$954.99  |
| A2 1/4-58 | 1/4 | 350   | 5100                       | 4260 | 3240 | 1680 | 22' | \$1024.99 |
| A2 1/3-63 | 1/3 | 460   | 5760                       | 4980 | 4080 | 2940 | 25' | \$1074.99 |
| A2 1/2-76 | 1/2 | 620   |                            | 7200 | 5760 | 3600 | 23' | \$1134.99 |

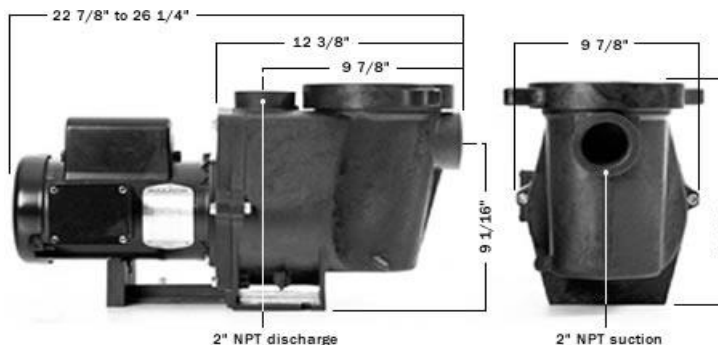

### Tips for installing an external pump.

- Keep your pump protected from weather. It should be brought in for winter or else drained.
- Allow adequate space for additional plumbing needed.
- Keep basket clear from debris.
- Use a check valve to avoid air-locking the pump when restarting.
- A pre-filter before the pump will make cleaning easier.

# Filters

***Pre-filters help to protect your pump and can provide biological filtration as well. Never clean all your filter media at one time. Beneficial bacteria that has been growing in the media will be destroyed by contaminated tap water or cleaning solutions.***

## Submersible Filters

### **Matala EZ Bio-Prefilter**

Prevents flow reduction due to premature clogging, extends pump life. Connects to many types of pumps and is easily extendable for increased capacity. Minimal maintenance – just rinse with water.

Single \$34.99 Double \$55.99                      Refill large green \$26.99 small black \$19.99



### **Matala Pump Defender**

Pump Defenders are designed to protect your submersible water pumps from clogging with debris. The pump sits inside a basket of green density Matala and then wrapped in a nylon bag with drawstring. Heavy debris is filtered out before it reaches the intake of the pump, thereby reducing maintenance and extending the life of the pump.

MPD – 6 6"x10" \$36.99                      MPD – 9 9"x13" \$39.99



### **Tempo Submersible Pond Filter**

Provides mechanical and biological filtration. Pump sits under filter pads preventing plugging. Comes complete with dual media – white inner roll provides biological surface area while black surface media traps debris. For ponds up to 600 gallons.

12.5" diameter x 10" tall. Max Flow 850 GPH. Fits tubing sizes 3/4" or 1". \$53.99

Replacement filter media Top \$12.99 Bottom \$15.99



### **Aquascape Submersible Filter**

Provides pond owners with efficient mechanical and biological filtration. This unobtrusive filter can be added to the intake of almost any submersible water pump resulting in clearer water and maintenance-free pumps. Removable cage for easy cleaning. Will handle flow rates up to 1300 GPH Includes 2x3/4", 1", 1.25" multi-hose fitting. \$79.99

Replacement Pad \$39.99 Replacement Ceramic Media \$17.99



### **Pondmax All in One Submersible Filter SF750**

Compact, submersible filter requires no complicated plumbing for dramatically simple filter installation. Built-in UV clarifier enhances pond water clarity by combating green water algae for beautiful, crystal clear water. 20' cord. Max flow 660 gph, 9 watt UV, For 375 gallon ponds with fish and sun. \$289.99

Replacements - UV Bulb(SF750-9w) \$39.99  
 UV Bulb (S650-13W) \$44.99  
 Filter Pad \$14.99  
 Bio-Rock \$9.99  
 Bio-Media \$9.99

Quartz Sleeve \$34.99  
 Fittings \$14.99  
 O Ring Kit \$4.99  
 Pump/UV combo only \$179.99  
 Impeller \$19.99



**Pump Sleeve**

Protects small submersible pumps from sucking in large debris that may cause pump damage. Easy to clean. Surrounds pump with filter media on side and bottom.

Mini 4.5"x3"x3.5" \$19.99 Small 6"x4"x3.5" \$24.99

**Replacement Filter Media**

|  |         |         |
|--|---------|---------|
| Carbon and Coarse for 190 Pump/filter Kit  |         | \$13.99 |
| Carbon and Coarse for PM1000               |         | \$16.99 |
| Foam for Pondmaster Models 2-7             |         | \$10.99 |
| Aquabelle for Pondmaster Models 2-7        |         | \$16.99 |
| Foam for Pondmaster Models 9-18            |         | \$16.99 |
| Lava Rock                                  |         | \$9.99  |
| Media Bag                                  |         | \$12.99 |
| Polyester Foam                             | 12"x12" | \$6.50  |
| 2" coarse                                  | 12"x18" | \$9.75  |
|  | 18"x18" | \$14.65 |
|  | 18"x24" | \$19.50 |
|  | 24"x24" | \$26.00 |
|  | 24"x36" | \$39.00 |
| Matala Filter Pad 24"x39"x1.5"             |         | \$49.99 |
| Matala Filter for Mini EP or Elite Skimmer |         | \$15.99 |
| Matala Filter for Small EP Skimmer         |         | \$18.99 |
| Savio Filter Mater                         |         | \$16.99 |
| Savio Skimmer Mat                          |         | \$13.99 |
| Savio Compact Skimmer Mat (2 pieces)       |         | \$11.99 |
| Tetra Clearchoice Replacement Pads         |         | \$26.99 |



***Submersible vs. External Filters***

Submersible filters work best in smaller ponds. The filter is connected to the intake of the pump and rests on the bottom of the ponds. They are sometimes difficult to pull up and clean on a regular basis, however, they are an excellent protection for you pump and contain enough media for good biological filtration in ponds less than 800 gallons. Submersible filters tend to be less expensive than external.

External filters provide easy access for cleaning. They can usually be camouflaged in the landscape. Due to their size, they provide a larger surface area for better biological filtration. Most external filters, if they are not pressurized, use gravity to move the water back to the pond, therefore, they must be above pond level at the re-entry point. External filters do not protect your pump from clogging, it is recommended that you make use of a pre-filter in the pond for mechanical filtration or keep the pump in a skimmer box for this purpose.



## Pressurized External Filters

### Pond Max Pressure Filter

Compact and effective filtration system of simple configuration and easy installation. Multiple fittings to adapt to different types of tubing. Low maintenance with cleaning indicator and backwash rinsing system. Double action biological sponges.

High surface area bio rings on PF2400, PF3600, PF4800, PF7200 models.

Optional ultraviolet clarifier to help maintain clear water.

Inlet/Outlet 3/4"/ 1"/1.25" PF750

Inlet/Outlet 1"/1.25"/1.5" PF1200, PF2400, PF3600

Inlet/Outlet 1.25"/ 1.5"/ 2" PF4800. PF7200



| Model  | Max Pond Size without fish Shaded | Max Pond Size with fish full sun | Max Flow | UV Size | Price with UV |
|--------|-----------------------------------|----------------------------------|----------|---------|---------------|
| PF750  | 750                               | 375                              | 1000 gph | 9 watt  | \$279.99      |
| PF1200 | 1200                              | 600                              | 1200 gph | 13 watt | \$429.99      |
| PF2400 | 2400                              | 1200                             | 1800 gph | 18 watt | \$509.99      |
| PF3600 | 3600                              | 1800                             | 3400 gph | 24 watt | \$639.99      |
| PF4800 | 4800                              | 2400                             | 3600 gph | 36 watt | \$699.99      |
| PF7200 | 7200                              | 3600                             | 4000 gph | 55 watt | \$864.99      |



| Model  | Annual Service Kit | Replacement Filter Pad Set | Replacement Quartz Sleeve | Replacement UV Bulb                         | UV Transformer |
|--------|--------------------|----------------------------|---------------------------|---|----------------|
| PF750  | \$109.99           | \$49.99                    | \$39.99                   | \$39.99 9 watt                              | \$119.99       |
| PF1200 | \$149.99           | \$79.99                    | \$44.99                   | \$44.99 13 watt                             | \$124.99       |
| PF2400 | \$169.99           | \$99.99                    | \$49.99                   | \$54.99 18 watt<br>Older models use 13 watt | \$164.99       |
| PF3600 | \$199.99           | \$129.99                   | \$54.99                   | \$59.99 24 watt<br>Older models use 18 watt | \$189.99       |
| PF4800 | \$259.99           | \$169.99                   | \$59.99                   | \$64.99 36 watt                             | \$229.99       |
| PF7200 | \$329.99           | \$229.99                   | \$74.99                   | \$69.99 55 watt                             | \$279.99       |

| Model  | Replacement O Ring Kit | Center Tube | Replacement Lid | Replacement Tank | Lid Clamp |
|--------|------------------------|-------------|-----------------|------------------|-----------|
| PF750  | \$19.99                | \$29.99     | \$89.99         | \$49.99          | \$24.99   |
| PF1200 | \$21.99                | \$34.99     | \$129.99        | \$99.99          | \$29.99   |
| PF2400 | \$21.99                | \$39.99     | \$139.99        | \$109.99         | \$29.99   |
| PF3600 | \$21.99                | \$44.99     | \$169.99        | \$119.99         | \$29.99   |
| PF4800 | \$34.99                | \$49.99     | \$179.99        | \$129.99         | \$44.99   |
| PF7200 | \$34.99                | \$54.99     | \$209.99        | \$159.99         | \$44.99   |

| Model                  | Ball Valve | Washers | Hosetails | Crank Handle |
|------------------------|------------|---------|-----------|--------------|
| PF750                  |            | \$1.99  | \$14.99   | \$8.99       |
| PF1200, PF2400, PF3600 | \$29.99    | \$2.99  | \$29.99   | \$8.99       |
| PF4800, PF7200         | \$33.99    | \$5.99  | \$39.99   | \$10.99      |

### ***Pressurized Filter vs. Gravity Filter***

While a pressurized filter sounds easy there is actually more maintenance involved than a filter that is camouflaged by the waterfall and gravity fed to the pond. The 2 big advantages to a pressure filter are the usually compact size and the fact that it can be hidden anywhere near the pond. However, they must be backwashed on a regular basis to avoid damage to the unit itself. A pressure filter greatly restricts the flow of the pump as it exits back to the pond. Sometimes complex plumbing is required to connect into a system.

Using a gravity filter as the start of your waterfall is easy during initial pond installation but may require some re-construction of the waterfall for existing ponds. These only need to be cleaned a few times throughout the season if they are sized properly for the pond and fish load. The biggest obstacle is the size of gravity filter since it must contain enough filter media to support the biological activity for the pond. Overall a gravity filter is usually less expensive to purchase and has fewer potential problem parts to replace down the road.

***Both filters will work best with a pre-filter such as a skimmer box to aid in mechanical filtration***

#### **Eazy Pod Filter Complete**

Mechanical, biological and ultraviolet filtration

- For the ultimate in clarity and ease of use
- Simple to install, easy to maintain
- Air Pump 70 Kit included
- 18 Watt UV Included

24.4" (w) x 25.8" (h) x 29.1"mm (d)

A compact member of the Nexus family, the EazyPod is a mechanical and biological filter system for ponds up to 2,640 gallons. The EazyPod utilises static K1<sup>®</sup> Micro, which provides enhanced biological benefits, even when using the EazyPod solely as a mechanical waste filter. \$1549.99

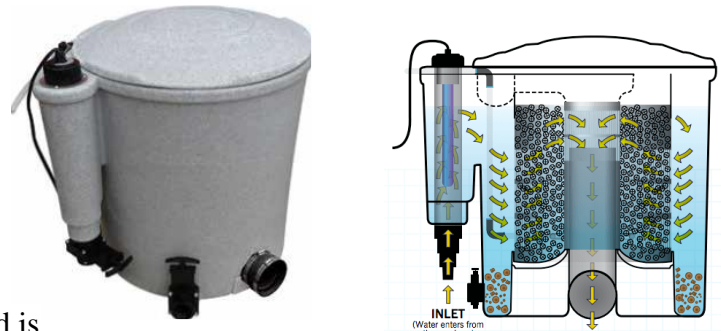

#### **K+ Pressure Filter**

- Uses K+ filter media for dramatically improved biological filtration compared to using beads
- Multi-port valve and blower included with all models
- Blower used during cleaning cycle
- Large clear viewing lid on top of the filter



Water is pumped into the filter from the pond through the multi-port valve where the internal pipework directs the water to the bottom of the unit. As the water flows upwards inside the K+ Pressure Filter, dirt, debris and waste are trapped within the mass of K+ filter media. The vast protected surface area provided by K+ Media also provides a home for the beneficial bacteria, along with filter feeders such as Vorticella and Rotifiers delivering mechanical and biological filtration. The filtered water flows back into the pipework at the top of the unit, through the multi-port valve and back down the return line into the pond. The K+ Pressure filter is incredibly easy to clean, by simply moving the handle on the multi-port valve into the corresponding positions to perform a backwash and a rinse of the K+ media.

|         |           |            |                              |
|---------|-----------|------------|------------------------------|
| K+ 3000 | \$1749.99 | 1 ½" ports | max pond volume 3000 gallons |
| K+ 9600 | \$2699.99 | 2" ports   | max pond volume 9600 gallons |

**Replacement Media K+ 25L \$139.99 50L \$249.99**

### Cetus Sleeve

Prefilter to remove waste and debris. The Cetus will allow a skimmer or a bottom drain to accept vast amounts of waste without excessive cleaning needed to be carried out. The water must then be pumped to either a normal filter above pond level (Nexus Eazy/Eazy Pod) or to a pressurized filter.

- Easy maintenance
- Reduced backwashing of pressure filters
- Simple installation with flexible connectors
- Patented pondflow regulation system
- Large waste collection which is easy to clean
- Robust one piece mould with no welded joints
- Can be installed on pump or gravity fed set-ups
- 22.6" (w) x 37.2" (h) x 33.9" (d)

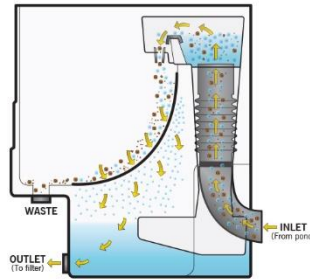

\$1599.99

### Nexus+ Filter

The Nexus+ filter is an innovative biological and mechanical filter system in one. Water from the pond enters the Nexus+ via the inlet into the inner chamber which works as a vortex allowing larger solids to settle out. The water then passes through Eazy filter, where fine particles are removed at the mechanical stage of filtration thanks to the static bed of K1 micro filter media. The mechanically clean water then passes to the outside chamber of the Nexus+ where the new K+Media moving bed is located for biological treatment prior to being returned to the pond. At this stage, biological breakdown occurs through different strain of bacteria and filter feeders living on the vast protected surface area of each piece of the K+Media. These bacteria convert Ammonia and Nitrite into less harmful Nitrate. Water then passes through the exit grill into the outlet, returning back to the pond.

Eazy220+ \$2499.99

Eazy320+ \$3199.99

(Nexus+ filters must be ordered - not stocked)

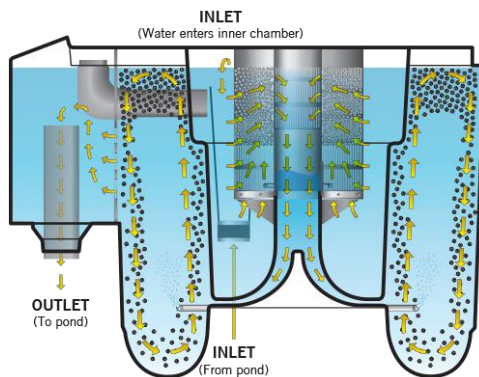

### 12" Detox Dechlorinator

High capacity, pre-washed carbon removes toxins in tap water. For use on ponds and indoor aquariums. No need to wait for chlorine to "gas-off" or to use liquid treatments. Easily connects to a hose pipe – fittings included. Also can be fitted to rigid pipe.

\$219.99



**Filters as part of Waterfall**

*The bottom of an up-flow gravity filter should be cleaned at least once per year. Solids will settle below the filter pads.*

**Easy Pro Aquafalls**

Aquafalls Filters have an inlet on each side of the filter. Use the one's that's most convenient for your incoming water and simply plug the other hole with a plug (included) or purchase a ball valve and use the second hole as a drain for easier cleaning. These filters have the simulated rock built right into the lip. Simply bolt lip to filter and you're done – no foaming rock lip into place. Aquafalls are buried into the ground making them easy to hide. Built extra strong. Use a grate on the top (sold separately) to even further hide the filter by placing rock over the top.

| Model  | Inlet Size | Size LxWxH  | For Ponds Up To | Waterfall Width | Max Flow   | Filter Price |
|--------|------------|-------------|-----------------|-----------------|------------|--------------|
| Small  | 2          | 26"x26"x26" | 2500 gallons    | 18"             | 4200 GPH   | \$519.99     |
| Medium | 2"         | 35"x36"x28" | 6000 gallons    | 26"             | 7200 GPH   | \$649.99     |
| Large  | 3"         | 36"x65"x36" | 15,000 gallons  | 50"             | 15,000 GPH | \$1269.99    |

**Rock Grate Sold Separately**

- Small \$59.99
- Medium \$159.99
- Large \$269.99

**Replacement Media**

- Small \$22.99 each pad
- Medium \$37.99 each pad
- Large \$64.99 each pad



*Pre-drilled holes for 2" bulkhead on each side of Small and Medium Aquafalls*

**Prelude Filter**

Easy and user friendly waterfall filter that requires no tools to attach liner. Includes filter box with "spliner lock" system, one filter pad, one bag of bio-blox media and one 1 1/4 PVC male adapter. For ponds up to 1000 gallons.

- 22"Lx17"Wx14"H
- With Lid \$189.99
- Without Lid \$139.99
- Replacement filter pad \$13.99

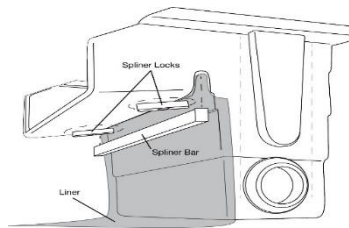

**Atlantic Water Garden Polyethylene Biofilter BF1600**

Sturdy top grate and support bar to allow natural rock camouflage. Dual bio-tech filter mats and media bag for biological filtration. Sturdy bottom grate supports filter medial. Rolled upper rim provides clean lines and incredible strength. One-piece liner attachment flange.

| Model  | Spill Width | Bulkhead | Max Pond Size | Max Flow | Price    |
|--------|-------------|----------|---------------|----------|----------|
| BF1600 | 16"         | 1 1/2"   | 1500 gallons  | 3000 GPH | \$340.99 |

Replacement Media Bag \$12.99      Replacement Filter Mat \$31.99





### Elite Waterfalls

Elite Series Waterfall Filters are absolutely the strongest, most durable waterfalls on the market! They come standard with Matala Biological Filtration Mats and include a Landscape Lid for concealing the unit within the landscape. The octagonal design provides maximum strength, and a much easier shape to camouflage than circular or rectangle designs. With 2 bulkhead openings, pipes can be installed from either side. The second opening can be used as a back flush to perform water changes or connect multiple pumps or plumbing lines. The two included Matala mats have two times the biological benefit and will last up to four times longer than traditional mats. These boxes come with self-tapping stainless steel screws for easy installation and corrosion resistance. Lastly, the waterfall snout is reversible. Install in the usual way for basic installation or reverse the snout for a more advanced waterfall appearance.

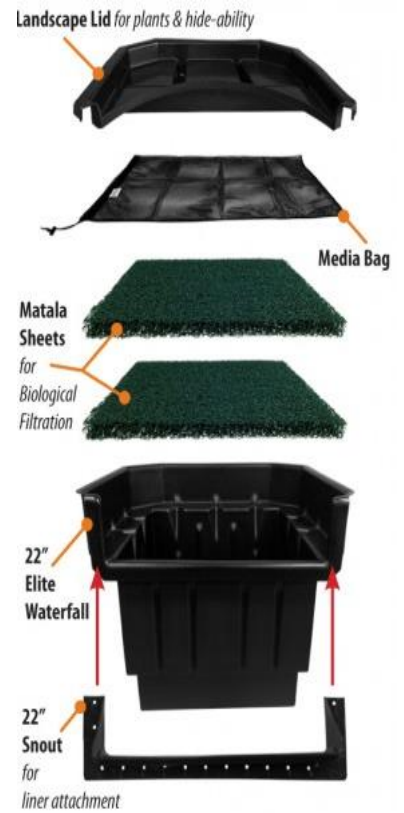

| Model        | Inlet Size | Size LxWxH          | For Ponds Up To | Waterfall Width | Max Flow   | Filter Price |
|--------------|------------|---------------------|-----------------|-----------------|------------|--------------|
| Small<br>14" | 2 – 2"     | 23"x24.75"x21.75"   | 1500 gallons    | 14"             | 3500 GPH   | \$429.99     |
| Large<br>30" | 2 - 3"     | 31.75"x40.5"x25.75" | 6000 gallons    | 30"             | 10,000 GPH | \$809.99     |

### Snorkel & Centipede Wetland Filter

Aquascapes patented Snorkel Vault and Centipede Module were specifically designed to tackle any number of the common issues that plague large scale water features. They are modular in design, allowing builders and designers the flexibility to expand the system to meet their needs. Highly effective at removing sediment (suspended solids) from the pond.

- Improves water clarity.
- Easily access collected sediment with the Snorkel Vault, reducing the need for costly and invasive dredging
- Works on earth bottom and liner membrane ponds
- Strips excess nutrients from the water column, reducing algae and the physical and chemical maintenance that goes along with removing algae
- Easily retrofitted onto existing ponds
- Create a waterfall and stream by designing the wetland filter system off the perimeter of the pond

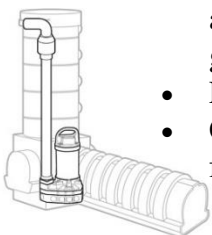

Snorkel \$669.99 Centipede \$439.99

# Skimmers

## Easy Pro Skimmer

Add a professional touch to any pond installation by providing an ideal place to hide the pump from view. A flange above the opening allows you to not only stack rocks along side the opening but also above the skimmer opening as well. Debris net and matala pad make cleaning easy.

| Model | Weir Width | Size L x W x H | Pond Size   | Max Pump Size | Price    |
|-------|------------|----------------|-------------|---------------|----------|
| Mini  | 6"         | 20"x15"x19"    | 250 sq. ft. | 3000 GPH      | \$359.99 |
| Small | 8"         | 28"x18"x20"    | 600 sq. ft. | 6000 GPH      | \$529.99 |
| Large | 16"        | 42"x20"x30"    | 600 sq. ft. | 18,000 GPH    | \$791.99 |



Extension Tube Mini/Small Skimmer \$109.99 Large Skimmer \$139.99  
Weir & Faceplate 8" \$69.99



|                | Mini    | Small    | Large    | Axiom  |
|----------------|---------|----------|----------|--------|
| Debris Net     | \$45.99 | \$59.99  | \$69.99  | 39.99  |
| 15" Brush each | \$9.99  | \$9.99   |          | \$9.99 |
| Lid            | \$54.99 | \$119.99 | \$169.99 |        |
| Matala Pad     | \$19.99 | \$29.99  |          |        |



## Axiom Skimmer

Features include front to back design – with the pump sitting behind the Debris net instead of alongside it. Adjustable overflow allows finished pond level to be adjusted. PSA7000 comes with dual 2" factory install spinweld fittings allowing for one or two pump installations. PSA9000 and PSA11000 come with two 2" and one 3" factory installed spinwelds.

| Model    | Weir Width | Size L x W x H | Recommended Flow Rate | Max Pump Size | Price    |
|----------|------------|----------------|-----------------------|---------------|----------|
| PSA7000  | 8"         | 29"x19"x21"    | 4500-6300 GPH         | 7000 GPH      | \$469.99 |
| PSA9000  | 8"         | 33"x19"x23"    | 6000-8100 GPH         | 9000 GPH      | \$529.99 |
| PSA11000 | 10"        | 33"x19"x23"    | 9100-9900 GPH         | 11000 GPH     | \$539.99 |



Extension for 7000/9000 \$109.99

## Skimmer for External Pump

Factory installed bulkhead fittings pre-plumbed for bottom drain connection. 8" weir inlet. Max flow 4500 gph. 20"x15"x 19" \$329.99

***Skimmers provide excellent pre-filtering capabilities as well as a way to keep the pump mechanics out of sight. We can help design a filter and skimmer system for you that has the best combination of mechanical and biological filtration for the size pond and pump you have.***



**Axiom Pond Skimmer/Filter Combo**

Combines mechanical and biological filtration in one. Includes debris net and filter brushes for mechanical filtration. A second compartment behind mechanical filtration holds biological media for complete water filtration.

3600 GPH Maximum flow rate. 8" Weir Width, 33"x19"x23" \$619.99

**Aquascape Signature 400 Skimmer**

Natural looking faux-rock lid to conceal in landscape. Rigid debris basket and filter mat for easy maintenance. Injection molded fittings for watertight seals. Rounded shape provides maximum strength. For ponds up to 400 sq. ft.

4000 GPH Maximum flow rate, 6" Weir Width.

21.5"x18"x21" \$589.99



**Elite Skimmer**

If reducing maintenance and protecting the life of your pond pump are important to you, then investing in a Pond Skimmer is key. The pond pump (sold separately), which is located inside the skimmer, draws water into the skimmer opening mechanically filtering out leaves, twigs and other floating garden pond debris trapping the debris inside a net and filter pad. Elite skimmers include matala filter mat and stainless steel frame as well as faux lid.



| Model  | Weir Width | Size<br>L x W x H    | Recommended<br>Flow Rate | Max Pump<br>Size | Max<br>Pond           | Price    |
|--------|------------|----------------------|--------------------------|------------------|-----------------------|----------|
| Small  | 8"         | 26.25"x15.25"x19.75" | 2500-3500 GPH            | 5000 GPH         | 11'x16'<br>or similar | \$449.99 |
| Medium | 10"        | 28.25"x19.25"x23.75" | 5000-7500 GPH            | 10,000 GPH       | 21'x26'<br>or similar | \$639.99 |

**Prelude In Pond Skimmer**

Installs inside the liner and requires no tools, no cutting the liner and therefore no leaks. Comes with debris basket, filter pad and lid. Max flow rate 1800 gpm, ideal of mag drive pumps.

18"x15"x13", 5" water inlet \$159.99



**Atlantic Satellite Skimmer**

Installs inside or outside the pond. Pump flow rates 1000-3000 gph.

13"W x 13"D x 25"H

6" weir width. \$239.99

**Pondmax In Pond Skimmer**

Easily connects to a variety of pumps with stepped hosetail fittings 1"/1.25"/1.5".

Telescoping design adjusts to different depths 22"-36". Great for retrofit applications and large receptacle base for weighting down. Minimum flow rate 1500 gph, Maximum flow rate 4000 gph \$129.99



**Auto-Fill Valves**

Maintain a consistent pond level by installing an auto-fill in the skimmer. Can be hooked into existing irrigation.

|                        |          |
|------------------------|----------|
| Brass Economy          | \$63.99  |
| Box Style              | \$46.99  |
| Atlantic Auto Fill     | \$41.99  |
| Easy Pro 1"            | \$134.99 |
| Aquascape Hudson Valve | \$79.99  |

# Pond Free Systems

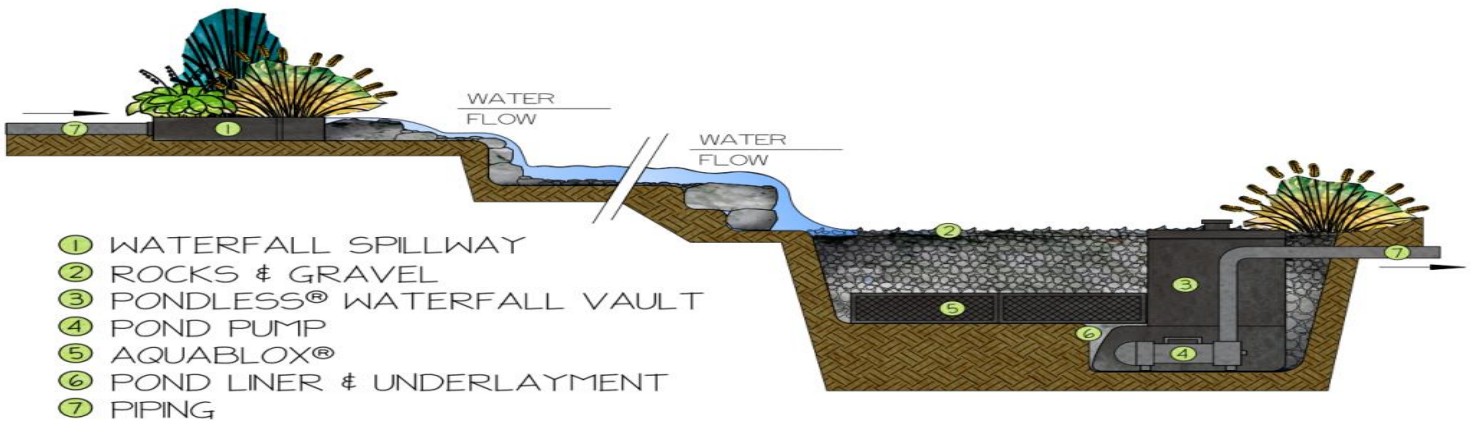

## Aquascape Pondless Vault

Simple to install and maintain. Large interior fits a wide range of pump sizes up to 12,500 GPH. Excellent water circulation through horizontal and vertical water intakes. Easy to camouflage with built in water level inspection port.

23"x17"x 25.5" \$419.99

Extension \$119.99



## Easy Pro Pump Vault

Roto-molded for excellent strength. Ideal for mag drive pumps.

Mini 13" diameter x 14.5" height, max flow 3000 GPH \$104.99

Medium 20" diameter x 20" height, max flow 10,000 gph \$199.99



## Easy Pro Pro Series Vault

Built heavy duty to withstand the pressure of being buried under rock. The slots cut in the sides allow water into the pump. 16"x16"x22" maximum flow is 7500 GPH \$229.99 Extension \$104.99

## Elite Small Canyon

One piece molded construction 15.5" x 18" x 22.5". Auto-Fill Spinweld Fitting and UniSeal accepts 2" flex hose. Max Pump Flow 7500 gph. \$299.99





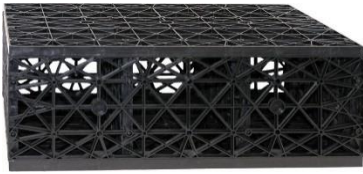

**Reservoir Cube High Strength**

Reservoir for pondless can be made smaller and fewer rocks used when using Res Cubes. Ideal for high weight bearing features and large boulders. Also great for under roadways, sidewalks and pathways. Can be used for water retention and recycling rain water. Quick assembly on site saves on space when shipping.

Small (1/2) 27"x16"x9.5" 17 gallons \$39.99      Large 27"x16"x17.5" 31 gallons \$59.99

**Calculating Reservoir Size & Cubes**

Calculate water volume in stream – L'xW"x.25x7.48  
 Reservoir should be at least 2x the volume in stream  
 Gallons in Reservoir divided by gallons in cube = number of cubes.  
 Reservoir should be dug to fit number of cubes and vault.

Stream 12' long and 2" wide = 45 gallons  
 Reservoir = at least 90 gallons  
 Small (1/2) Reservoir Cube = 17 gallons  
 90 divided by 17 = 6 Small 1/2 Cubes

*Lay out cubes (stacked 2 high) and vault to determine size of reservoir (approximately 5'x3'x2' deep)*



**Pond Free Waterfall Weir**

**Pondmaster Proline Waterfall Box**

Create a waterfall or stream in tight spaces using the waterfall box. Easy to conceal by burying it into the ground. You supply media for biological filtration.

|         |               |                 |         |
|---------|---------------|-----------------|---------|
| Pro1000 | 12"Lx9"Wx7"H  | 8" opening      | \$51.99 |
| Pro2000 | 15"Lx12"Wx9"H | 11 1/4" opening | \$61.99 |



**Aquascape Waterfall Spillway**

Durable design makes it easy to disguise by allowing soil, rocks or logs to be placed directly on top of the unit. Comes complete with a 2" PVC slip fitting, 1 1/2" barbed hose fitting and pre-installed bulkhead.

22" wide spillway handles flow rate up to 7500 GPH. \$249.99  
 12" wide spillway handles flow rate up to 4000 GPH \$209.99



**Easy Pro Waterfall Diffuser**

Fast and easy way to create professional looking waterfalls. Ideal for use at beginning of streams and in block walls, pools and formal fountains. Super strong vertical rib design creates a nearly indestructible diffuser. Can be used in multiples for wider applications. Dual 2" inlets.

|                                 |               |          |
|---------------------------------|---------------|----------|
| 23" wide x 14" deep x 3.5" tall | 1500-6000 gph | \$149.99 |
| 16" wide x 14" deep x 3.5" tall | 1000-4000 gph | \$114.99 |



Country Gardens  
(978)948-2124

**Cascade Box 10"**

Waterfall width 10" Spillway. Inlet Size: (2) 1" Spinweld. Includes landscape lid attached. 8.5" x 10" x 8" . Max. Pump Flow 1800 gph \$89.99



**Corner Falls**

Fits tightly into any corner install inside liner or with liner attached to front. Waterfall width 12". Dual inlets size 1.5". Max flow rater 2500 gph 12"x12"x10"h \$179.99

**Vianti Falls Stainless Steel Spillway**

This spillway has a 6" lip. Internal baffle calm incoming water – creating an even and smooth flow over the lip. 1" fpt connections. Ideal for formal features, signs and swimming pool features.

23" wide – recommended flow rate 1200 gph - \$449.99

35" wide – recommended flow rate 1800 gph - \$549.99

Custom sizes available from 11.5" -71.5" wide.



**CabrioColor Light Strip 23" for Vianti Spillway**

Compatible with Viante Falls 23" spillway. Wide spectrum of color options.

15' power cord with quick connect fittings.

1 year warranty. Includes remote \$219.99

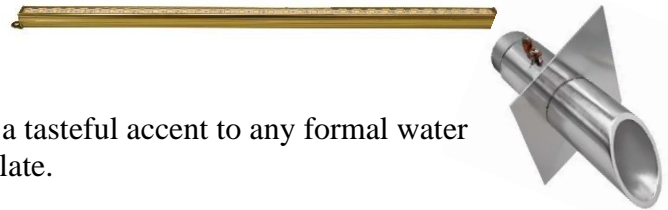

**Viante Wall Scupper**

Stainless Steel. A classic stand-alon water feature or use as a tasteful accent to any formal water feature. 2" diameter by 8" long. 4.5" x 6.5" diamond trim plate.

5-10 gph recommended flow rate. 1" fpt inlet. \$179.99



**Spillway Basin**

Basin has a pre-filter pump chamber and built in plumbing channels. Anti-splash mat installs on top of basin to virtually eliminate splash and reduce water loss. Cover the mat around the waterfall with gravel for a \more natural look.

|     | Basin    | Splash Mat |
|-----|----------|------------|
| 24" | \$462.99 | \$69.99    |
| 36" | \$525.99 | \$92.99    |



**Stainless Steel Splash Ring**

Keep stones in place and splash at bay with style. Set the mesh panel facing up to sow off the broad trim ring or flip the Splash Ring over to keep stones in place almost invisibly. Placing an LED light under the mesh to illuminate the falls from below while hiding the light from direct view adds nocturnal charm.

24" \$306.99 36" \$389.99

# Ultra Violet Light

## Evo UV

The Evolution Aqua evoUV delivers a more efficient and economical performance than before. The range includes a completely redesigned 15 Watt, 30 Watt and 110 Watt model that are perfect for use on a variety of garden ponds. The evoUVs are designed to clear and mitigate green water which is typically caused by single celled green algae. The evoUVs are compatible with various filtration systems but when paired alongside Evolution Aqua's pond filtration systems, the evoUV will deliver crystal clear and healthy pond water.

- Eradicates green water in garden ponds
- Features highly efficient ballasts
- IP Rating of IPX5
- Easy to maintain, easy to install
- Ballast located in a fully water-tight cover
- Connects to flexi-hose or rigid pipework



| Model  | Max pond Size | Max Flow Rate | Bulb Power           | Inlet/Outlet | Fittings Supplied                   | Dimensions           | Price    |
|--------|---------------|---------------|----------------------|--------------|-------------------------------------|----------------------|----------|
| EVO15  | 2000 gallons  | 2000 gph      | 15 watt<br>1x15w T8  | 1 1/2"       | 2 x 1 1/2"<br>Threaded<br>Hosetails | 23" long<br>7" wide  | \$299.99 |
| EVO30  | 3800 gallons  | 4000 gph      | 30 watt<br>1x30w T8  | 1 1/2"       | 2 x 1 1/2"<br>Threaded<br>Hosetails | 39" long<br>7" wide  | \$439.99 |
| EVO110 | 9750 gallons  | 6000 gph      | 110 watt<br>2x55w T8 | 2"           | No fittings                         | 41" long<br>12" wide | \$999.99 |

## Replacement Parts

|         | T8 Bulbs | Quartz Sleeve | O'Ring  |
|---------|----------|---------------|---------|
| 15 watt | \$39.99  | \$49.99       | \$11.99 |
| 30 watt | \$64.99  | \$59.99       | \$11.99 |
| 55 watt | \$79.99  | \$59.99       | \$13.99 |

Replacement Power Supply/Transformer \$99.99

Evo UV Union 1.5" \$39.99



## Aqua Ultra Violet UV Advantage UV



The Advantage Series is ideal for small ponds, aquariums, and water features. Advantage UV's are slim, lightweight units designed for maximum UV effectiveness. Aqua Ultraviolet UV's will clear your water in 3 to 5 days sometimes overnight and keep it that way. Performance is guaranteed when sized, installed and operated according to our instructions. 3/4" barbed inlet

and outlet. 15 watt for ponds up to 500 gallons, max flow 700 gph \$269.99

Replacement Bulb \$72.99

Replacement Quartz Sleeve \$59.99

Replacement Transformer \$109.99

**Teton Professional UV Clarifier**

Offers multi-directional 2” outlet for ease of plumbing. The 16 watt model is aluminum housing while the larger are stainless steel. These metal housing have a more reflective capacity for the UVC and are durable. 2 year warranty on the ballast and a 5 year warranty on the housing.

| Model    | Max Flow | Pond Volume    | Inlet Outlet | Price     |
|----------|----------|----------------|--------------|-----------|
| 16 watt  | 2250 gph | 4500 gallons   | 2”           | \$399.99  |
| 40 watt  | 3750 gph | 7500 gallons   | 2”           | \$599.99  |
| 80 watt  | 5000 gph | 10,000 gallons | 2”           | \$749.99  |
| 120 watt | 7000 gph | 14,000 gallons | 2”           | \$1049.99 |



**Replacement UV Parts**

**Smart UV Models**

| Model      | UV Lamp  | Quartz Sleeve | Power Supply |
|------------|----------|---------------|--------------|
| 18 watt    | \$93.99  | \$54.99       | \$155.99     |
| 25 watt    | \$95.99  | \$64.99       | \$155.99     |
| 40 watt    | \$99.99  | \$89.99       | \$155.99     |
| 80 watt HO | \$109.99 | \$89.99       | \$199.99     |

4 pin connector with starter bulb \$24.99      without bulb \$10.99  
Service Kit \$39.99



*In order for a UV to work properly it must be sized not only to the pond size but also the flow rate of the pump. Stagnant areas within the pond will also impact how well the UV clears green water. Does not kill string algae.*

*UV Bulbs should be replaced annually. If the unit is oversized for the pond you may get a longer bulb life. A good indication that the bulb needs replacing is that the water is turning green. An older bulb may still light, but not have the necessary UV to kill alae. A bulb that does not light usually indicates a power problem rather than an old bulb.*



# Under Water Lights

## PondMax Pond and Garden Lighting

Safe, Simple and Cost-Effective. LED lights in either warm white or color-changing. 2 sizes offer versatile connectivity and numerous mounting options. Rated for underwater and outdoor use. Can be daisy chained for easy connections.

### White Only Light

3 Light Complete Kit – includes 1 starter light, 2 add-on lights, transformer and photocell. 2 additional add on lights can be purchased to be used with kit.

Large \$304.99      Replacement Bulb \$29.99  
Small \$254.99      \$24.99

### Add On Light

Includes light fixture, weighted base, garden stake, 9' of cable.  
(cannot be used without starter light and transformer)

Large \$79.99  
Small \$69.99

### Single Starter Light

Includes fixture, weighted base, garden stake, 16' of cable, 3' transformer adapter cable.  
(needs transformer sold separately)

Large \$89.99  
Small \$79.99

### Color Changing Light

3 Light Complete Kit – includes 1 starter light, 2 add-on lights, remote and receiver to change colors, transformer and photocell. 2 additional add on lights can be purchased to be used with kit.

Large \$464.99      Replacement Bulb \$54.99  
Small \$334.99      \$26.99

### Add On Light

Includes light fixture, weighted base, garden stake, 9' of cable.  
(cannot be used without starter light and transformer)

Large \$99.99  
Small \$64.99

### Single Starter Light

Includes fixture, weighted base, garden stake, 16' of cable, 3' transformer adapter cable, remote and receiver to change colors. (needs transformer sold separately)

Large \$214.99  
Small \$174.99

### Fountain & Waterfall Light Kit

3 LED lights 2.8 watts each with 18 watt transformer included.  
First light is 16' from transformer then lights are daisy changed together with 5' between each light. \$149.99  
Add on light for Light Kit \$69.99



Consider your night-time pond viewing. Most of us work all day and could benefit from the relaxing sound of the waterfall in the evening. Illuminating the water with underwater lighting enables you to enjoy your fish anytime. You can choose a soft clear light or a variety of colored lenses can change the atmosphere. These are low voltage lights which sometimes can be tied into existing low voltage garden lights or used on their own.

**\*\*The one of the best areas to place lights is under the waterfall\*\***

**Accessories**

- 24 watt Transformer \$49.99
- 36 watt Transformer \$54.99
- Photocell (ON at dusk, OFF at dawn) Handles up to 100 watts. \$34.99
- Photocell with Timer \$44.99
- 16' Extension Cable. Handles up to 100 watts \$42.99
  - 2 pin for white LED lights
  - 4 pin for color changing LED lights
- 3 way Splitter \$14.99
- 5 way Splitter for white \$18.99 for color \$64.99
- Color Controller \$119.99
- Remote for Color Controller \$24.99



**LED Ring/Statuary Lights**

Barbed inlet fitting for use with 3/4" tubing. 10' power cord between light and transformer, 6' power cord on transformer. Light ring is 1 3/8" diameter with center hole for water to pass through. Single \$39.99 Triple \$79.99

**LED Color Changing Lights**

All-in-one kit developed to provide an impressive accent to fountains, connecting easily to the top of the fountain with an integrated barbed fitting. Wide variety of color options, and the integrated white diodes provide a true, warm white light when desired. These low-voltage lights are extremely energy-efficient and include professional, weatherproof quick-connect fittings for quick and easy installation. The kit includes one fountain light, a 12-volt transformer, and a wireless remote used to control the light settings. \$121.99



**Aquascape LED Accessories**

- 6 watt Transformer \$39.99
- 3 way splitter \$16.99
- 25' Extension Cable \$26.99
- Photocell \$40.99



**Aquascape Smart Control Plug**

Allows you to control and monitor outdoor electronics from your anywhere using your Smart phone or Tablet. The plug features three outlets so you can control three products simultaneously. Use dynamic scheduling to have products turn on automatically when you need them and get real-time energy consumption data for any electronic device. The device also works with Alexa for easy voice control. Adequate wireless coverage is required (2.4 GHz supported). 3-year limited warranty \$69.99

# Disappearing Fountains

Create a low maintenance water feature with a disappearing basin. These reservoirs are made of high density polyethylene. Any statuary or pottery that can be plumbed can be used as the focal point of your fountain.

## Atlantic Fountain Basin

One piece construction provides exceptional strength. Built-in channels simplify installation, allowing the plumbing to be run on top of the basin. Molded cones support the top panel. 1 1/2" conduit recessed allow for clean installation in surrounding masonry without noticing. Flat panel for optional Auto Fill installation. 32" is round, 24" and 45" are square

| <u>Model</u> | <u>Max Pump</u> | <u>Plumbing Size</u> | <u>Capacity</u> | <u>Supports Up To</u> | <u>Price</u> |
|--------------|-----------------|----------------------|-----------------|-----------------------|--------------|
| FB2400       | 750 gph         | up to 1/2"           | 20 gallons      | 200 lbs.              | \$204.99     |
| FB3200       | 2000 gph        | (3) 3/4" or (1) 1"   | 32 gallons      | 400 lbs               | \$395.99     |
| FB4700       | 4000 gph        | up to 1 1/2"         | 75 gallons      | 1200 lbs              | \$699.99     |



## Eco Rise

Strong radial structure handles the weight of heavier statuary, vases and columns while providing a broad stable base over pondless reservoirs. Keeps plumbing and flow adjustments topside for easy access.

20"x20"x3" Max load 3,000 lbs.  
\$124.99

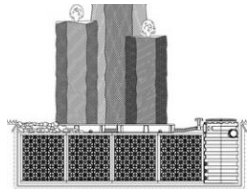

## Aquabasin 45

The basin is constructed of professional-grade, high-density polyethylene. Handles pump flow rates up 4,000 gallons per hour and can store up to 98 gallons of water. Drillable deck cylinders across the top of the basin provide endless plumbing and lighting options and keep unsightly cables and plumbing out of sight. The large, flat deck makes it easy to set and position fountains and the center cylinder is pre-drilled for plumbing single fountain applications. A pump access panel with integrated handle makes it easy to remove the cover for pump access. The large size of the corner access is compatible with larger pumps and is the area is elevated to prevent gravel from falling into the basin during pump maintenance. \$699.99





**Aura Vase**

The timeless beauty of brass complement any landscape. Hand-hammered of solid brass. Acid wash finish imparts an attractive unique patina to the surface. Solid brass standpipes create a bubbling fountain effect. Dual 1.5" threaded inlets allow water supply to be plumbed independently from light cords using Cord Seal Fitting.

24" \$979.99 flow rate 500-1000 gph  
 \$995.99 with spillway  
 32" 1335.99 flow rate 750-1500 gph

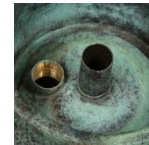
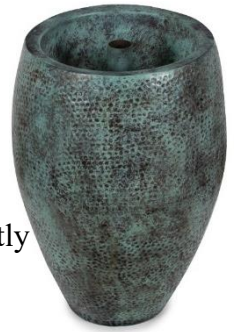

**Aged Tipped Copper Vase**

Deco-crete garden art that can be enjoyed for years. Deep cavity and large inlet tubing allow for higher flow up to 1000 gph. Includes 3' of 3/4" tubing. 14" long x 20" wide x 17" tall  
 \$129.99



**Smooth Vase Terra**

Deco Crete material provides the look and durability of traditional concrete without the cumbersome weight. Made with alternative concrete material that is fiber reinforced for strength. Includes 3' of tubing. 19"x19" x 21" tall. \$159.99



**Bamboo Basalt Fountain**

Taller basalt is core drilled with 1.25" hole at the bottom and connects to side hole for bamboo attachment. Water cascades from bamboo spout to lower basalt stone which overflows into basin below.

39" pillar basalt approx. 8"-10" diameter  
 8"-10" tall lower stone approx. 12"-15" diameter  
 2 piece weight 320 lbs  
 \$1039.99 basin and pump sold separately – ask about complete kit



**Bevel Sided Basalt 16"**

Polished on 2 sides with smooth polished top. 14-16" average diameter. Column is core drilled with a 1.25" hole from end to end the last 1.5" is enlarged to hide light ring. Size and weight will vary due to natural characteristics  
 \$449.99

**Basalt Rock Columns (Polished Top)**

Natural cut sides with polished ends make for a beautiful display even if the pump is off. Each column is core drilled with a 1 1/4" hole from end to end. The last 1 1/2" is enlarged to 1 3/8" to hide light ring (sold separately). Recommended flow rate 200-400 GPH per column.

Trio 20"/27"/35" \$1499.99 (350 lbs.)



*Lights available on page 34*



### Eternal Springs Rock Collection

Quality light weight concrete bubbler rocks offering exceptional realism, simple installation and easy maintenance. Constructed from Glass Fiber Reinforced Concrete.



Agate Falls \$229.99  
18"x19"x13" 44 lbs  
Recommended pump 370 gph

Triple Cascade \$469.99  
32"x18"x24" 60 lbs  
Recommended pump 1110 gph



Sonoma \$399.99  
12"x17"x24" 50 lbs  
Recommended Pump 660 gph

Klamath \$399.99  
18"x19"x16" 42 lbs  
Recommended pump 530 gph



Alder Falls \$299.99  
20"x22"x16" 50 lbs  
Recommended pump 660 gph



Sand River Falls \$459.99  
28"x24"x17" 86 lbs  
Recommended pump 800 gph



Agawa Falls \$189.99  
17"x14"x9"  
Recommended pump 290 gph





**Twister Mini Fountain Kit**

Includes basin, pump, plumbing, and color light kit. (pebbles sold separately)  
fountain 12”x12” basin 16”x16”x16”  
\$599.99



**Faux Basalt Columns**

Three columns measuring 24 inches, 30 inches, and 36 inches in height. Each column is molded from real basalts and handmade in the USA using fiberglass, resin, and real stone to provide an extremely realistic and durable fountain. Real basalt is extremely heavy and can be difficult to install. Due to the lightweight nature of the faux basalts, installation is quick and easy. Each column provides a convenient base, making it easy to secure in place using decorative gravel.

- Trio \$1399.00
- 24” \$419.99
- 30” \$469.99
- 36” \$569.99



**Spillway Bowl/Basin**

Create a beautiful spilling water feature in a variety of installation possibilities. Either can be installed as a standalone disappearing water feature or installed into an existing pond or water feature. Combine the Spillway Bowl with the Spillway Basin, Spillway Bowl Stand, and water basin for an incredible standalone feature that is sure to impress. Made from durable GFRC, this incredible decorative feature is easy to install and built for years of trouble-free enjoyment. Its unique patina finish allows the blend to blend naturally into any environment. The included standpipe provides multiple options for tweaking the water flow after installation.



|                          | <b>Small Spillway Bowl</b> | <b>Small Basin</b> | <b>Small Stand</b> | <b>Medium Spillway Bowl</b> | <b>Medium Basin</b>      | <b>Medium Stand</b>   |
|--------------------------|----------------------------|--------------------|--------------------|-----------------------------|--------------------------|-----------------------|
| <b>Size</b>              | 19” diameter               | 21” diameter       | 6” tall            | 32” diameter<br>14.5” tall  | 40” diameter<br>16” tall | 13.5” wide<br>4” tall |
| <b>Recommended Pump</b>  | 800 gph                    |                    |                    | 2000 gph                    |                          |                       |
| <b>Recommended Basin</b> | FB3200                     |                    |                    | FB4700 or AquaBasin 45      |                          |                       |
| <b>Price</b>             | \$199.99                   | \$219.99           | \$69.99<br>2 pack  | \$499.99                    | \$729.99                 | \$129.99<br>2 pack    |





**Urns, Sphere & Wall**

Made from lightweight, durable fiberglass-resin composite providing the look and beauty of real stacked slate stone. These unique water features are extremely versatile for use in a wide variety of applications, including standalone fountains, pond edges, or the start of waterfalls and streams.

**Stacked Slate Urn**

|                          | Mini     | X-Small                     | Small                         | Medium                    | Large                      |
|--------------------------|----------|-----------------------------|-------------------------------|---------------------------|----------------------------|
| <b>Size</b>              | 13" tall | 21.25" diameter<br>24" tall | 21.25" diameter<br>33.5" tall | 27" diameter<br>45" tall  | 35.5" diameter<br>55" tall |
| <b>Recommended Pump</b>  |          | 550 gph                     | 550 gph                       | 1250 gph                  |                            |
| <b>Recommended Basin</b> | FB2400   | FB3200                      | FB4700 or<br>AquaBasin 45     | FB4700 or<br>AquaBasin 45 | Custom Liner &<br>Cubes    |
| <b>Price</b>             | \$109.99 | \$299.99                    | \$549.99                      | \$899.99                  | \$1499.99                  |

**Stacked Slate Sphere**

|                          | Small                     | Medium                    | Large                      |
|--------------------------|---------------------------|---------------------------|----------------------------|
| <b>Size</b>              | 24" diameter<br>22" tall  | 32" diameter<br>30" tall  | 40" diameter<br>37.5" tall |
| <b>Recommended Pump</b>  | 800 gph                   | 1500 gph                  | 2000 gph                   |
| <b>Recommended Basin</b> | FB4700 or<br>AquaBasin 45 | FB4700 or<br>AquaBasin 45 | Custom Liner &<br>Cubes    |
| <b>Price</b>             | \$549.99                  | \$899.99                  | \$1499.99                  |



**Scalloped Urn**



|                          | Small                     | Medium                    | Large                    |
|--------------------------|---------------------------|---------------------------|--------------------------|
| <b>Size</b>              | 20" diameter<br>32" tall  | 27" diameter<br>45" tall  | 38" diameter<br>56" tall |
| <b>Recommended Pump</b>  | 550 gph                   | 1250 gph                  | 2000 gph                 |
| <b>Recommended Basin</b> | FB4700 or<br>AquaBasin 45 | FB4700 or<br>AquaBasin 45 | Custom Liner &<br>Cubes  |
| <b>Price</b>             | \$549.99                  | \$899.99                  | \$1499.99                |

**Stacked Slate Spillway Wall**

36" long x 12" wide x 32" tall  
Recommended Pump 2000 gph or larger pump.  
Recommended Basin FB4700 or AquaBasin45  
\$919.99 Available in curved or straight wall

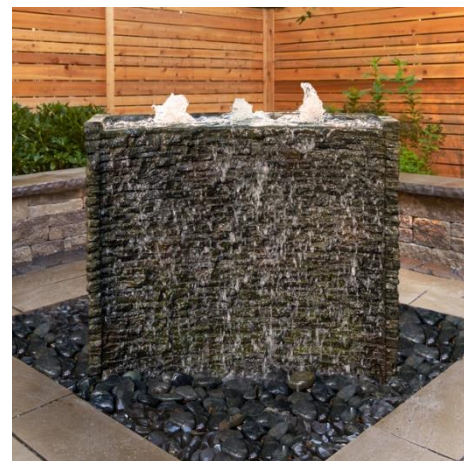

**Ask about our complete fountain kits**

## ***The Balanced Pond***

The lure of the pond is, of course, its fish and aquatic plants. In creating a water garden you are establishing a miniature ecosystem, balance is essential. Planting the pool precedes the stocking with fish. Plants will balance a pool by oxygenating it (they absorb carbon-dioxide and exude oxygen, while fish do the opposite) and by shading it from excessive sunlight. Too much sunlight encourages the rapid growth of algae.

Typically, the balancing will follow this course. New water will be clear, but once sunlight has penetrated it a green algae will form. This is a natural reaction due to the many nutrients in the water. Aquatic plants compete with algae for these nutrients and they will eventually win over if they are stocked in the proper ratio. Be sure to use floating plants or water lilies to cut out the amount of sunlight in the water. Because your water garden is a closed miniature ecosystem, a filter helps to provide a breeding bed for nitrifying bacteria used in the ponds nitrogen cycle. Seeding the filter with bacteria will give a jump start in the spring after a cold winter to speed the balancing process.

Plants themselves should be introduced to the pond during the growing season. To achieve the correct biological balance in your aquatic ecosystem, you should have a collection of the following:

\*Oxygenators: Essential for maintaining water clarity. They also help to benefit fish as they absorb sunlight and emit oxygen. One bunch for every two square feet or 1 bag per 5 square feet.

\*Deep Water Plants: Decorative, colorful blooms such as the well-known lily. Available in many shades of white, pink, red, and yellow.

\*Marginals: Planted in shallower water, these help to break up the formal edges of a pool, giving a more natural appearance. Many varieties of contrasting color and foliage.

\*Floating Plants: These help control blanket weed and green water by minimizing the amount of sunlight on the water surface.

Although there is much variation in pool planting, we recommend the following guidelines when planting the pond:

- ❖ Cover at 50-70% of the surface area with floating plants and lilies during the summer months to block sunlight and deter algae growth
- ❖ Submerged plants can be put out early in the pond and can provide hiding places for small fish
- ❖ Marginal plants provided different textures, colors, and heights for a visually pleasing pond
- ❖ Plants will need to be transplanted and thinned out as the pond matures.

Start with the following stocking formulas and adjusted to your pond plant preferences:

|  |
|--|
| <p><b><i>For small pools up to 300 gallons:</i></b><br/>1-3 bag oxygenators, 2 marginals, 3 floating plants</p> <p><b><i>For medium pools 300-1000 gallons:</i></b><br/>3-8 bags oxygenators, 4-8 marginals, 3-6 floating plants, 1-2 water lily</p> <p><b><i>For large pools about 1000-2500 gallons:</i></b><br/>10-16 bags oxygenators, 6-10 marginals, 6-12 floating plants, 1-3 water lily</p> <p><b><i>For very large pools over 2500 gallons:</i></b><br/>20 bags oxygenators, 12-18 marginals, 12-24 floating plants, 5-8 water lilies</p> |
|--|

*\*floating plant count refers to initial spring purchase*



Two to three weeks after planting, you may wish to introduce fish to your pond. There are many varieties of hardy pond fish that can be mixed safely together, including the exotic Koi Carp, the hardy Goldfish, the active Golden Orfe, the graceful Shubunkin, and the brilliant Comet Goldfish.

In general, the stocking ratio for a new pool should be 1" to 2" of fish for every square foot of water surface. Maintaining this level will ensure that conditions in the pool remain healthy. Further, the pool's total fish collection should be introduced gradually over a period of time so that the total ecosystem can adapt, taking into consideration the growth potential of the fish.

A large fish population is the other reason to include a biological filter in your pond. Fish waste can be toxic if not controlled by nitrifying bacteria. This bacteria help to take this toxic substance and convert it to nitrate, a plant nutrient.

When introducing the new fish to the pool, float the unopened bag on the pond surface for fifteen to twenty minutes, so that the temperature of the water inside the bag will adjust to that of the pond. You can also introduce several cupfuls of the pond water into the bag to help minimize stress due to the changes in water chemistry. Once the water has adjusted, release the fish slowly into the pond. Their natural tendency to hide in depths will quickly be overcome as the fish adapt to their new environment. Once acclimated, they will readily swim to the surface for feeding.

Finally, one of the most aesthetically pleasing ways to help keep both your fish and plants vibrant in clear, healthy water is the introduction of a fountain ornament or waterfall. Sculptures and waterfalls move water continuously for a cleansing and aerating effect which is essential to the survival of your eco-system. They blend beautifully as a graceful accent to any natural pond setting.

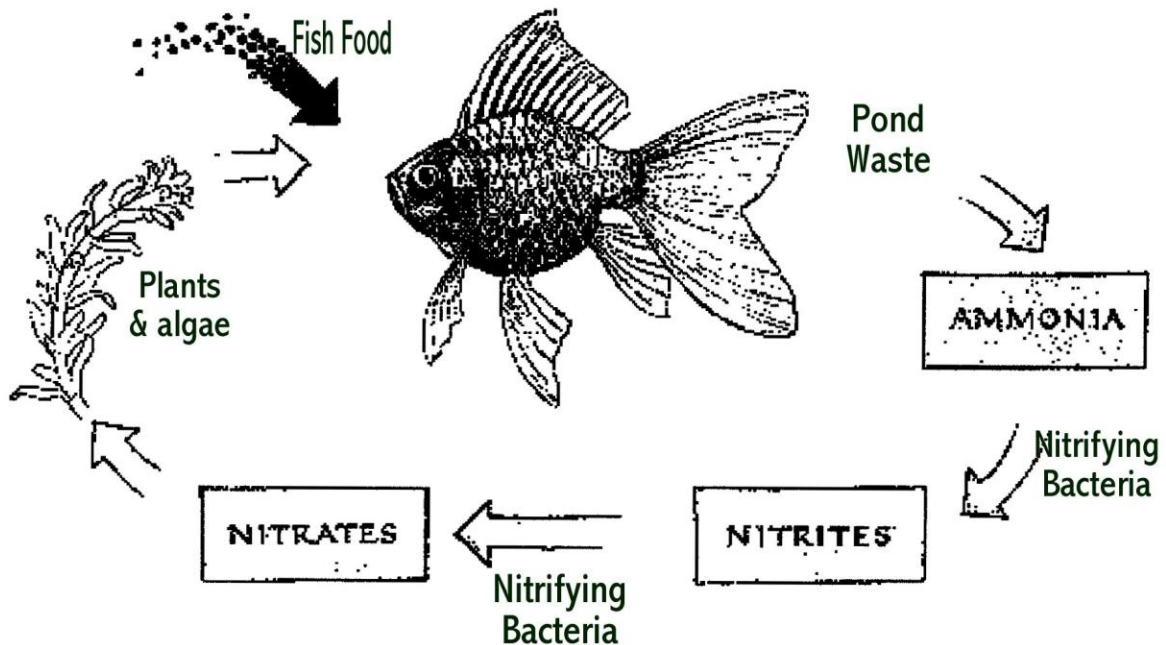

## The Nitrogen Cycle

## ***Water Lilies (Nymphaea)***

Pads floating on the surface and colorful blooms of the water lily make it the most popular aquatic plant for water gardens. But they are not just a pretty addition - they provide shade and protection for the fish as well as consuming nutrients and sunlight loved by algae. The range of colors available are sure to complement any pond landscape.

For spectacular lilies the following guidelines should be taken:

- ✓ Minimum pot size of 10" should be used (16"-20" better)
- ✓ Prune and fertilize every 2-4 weeks throughout the season
- ✓ Depth of 12-24" over tuber is ideal
- ✓ 6 Hours of sunlight is ideal

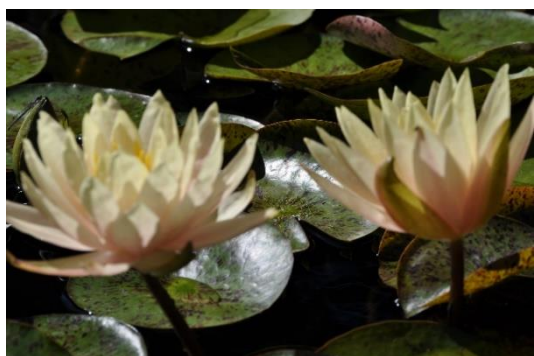

### ***Hardy***

Hardy water lilies are all perennial and will bloom year after year even in the coldest areas of this country. Generally their blossoms float on the surface of the water, raising them up above only in very crowded conditions. All are day blooming with flowers that open late morning and close late afternoon repeatedly for 3 to 5 days. New blossoms should keep coming throughout the summer months. As fall approaches the hardy lily will show fewer and smaller pads eventually dying back for the winter. Containers should be placed in water below

ice line to keep plant tuber from freezing in winter. Blossoms can be yellow, pink to red shades, white or peach to orange shades. Repotting is usually necessary every 2-3 years



### ***Tropical***

Tropical lilies are best in ponds where daytime temperatures average 70 degrees or from May 25 - September 1. In addition to a wider variety of colors than a hardy lily, the blossoms of a tropical lily usually rise above the surface of the water and often multiple blossoms will open on one plant. The pads are larger with scalloped edges and some will have a purple mottling. In addition to the traditional day blooming lily, night-blooming tropical lilies open late afternoon and close early morning. They will bloom until the frost. Blooms in

blues, purples, yellow, pink to red shades, white. Over-wintering can be difficult in northern climates so we recommend discarding a tropical lily each fall.

### ***Intersubgeneric!***

Many hybridizers have been working on crossing a hardy lily with the tropical lilies to get the best characteristics of each in one lily! While still just a few varieties available, we now have a purple hardy water lily.



## ***Lotus (Nelumbo)***

Lotus take a year to become established. They send up aerial leaves and sometimes blossoms the first season. Blossoms begin in July, with the blooming season lasting 6 to 8 weeks. Blossoms open early in the morning and close in mid-afternoon. They need 5 to 6 hours of sunlight minimum and prefer still water that is 2 to 4 inches above the soil. Lotus require several weeks of sunny weather in the 80's in order to bloom. They do best if fed heavily and planted in large containers (except for smaller varieties).



### **Cross-Section of a Pond**

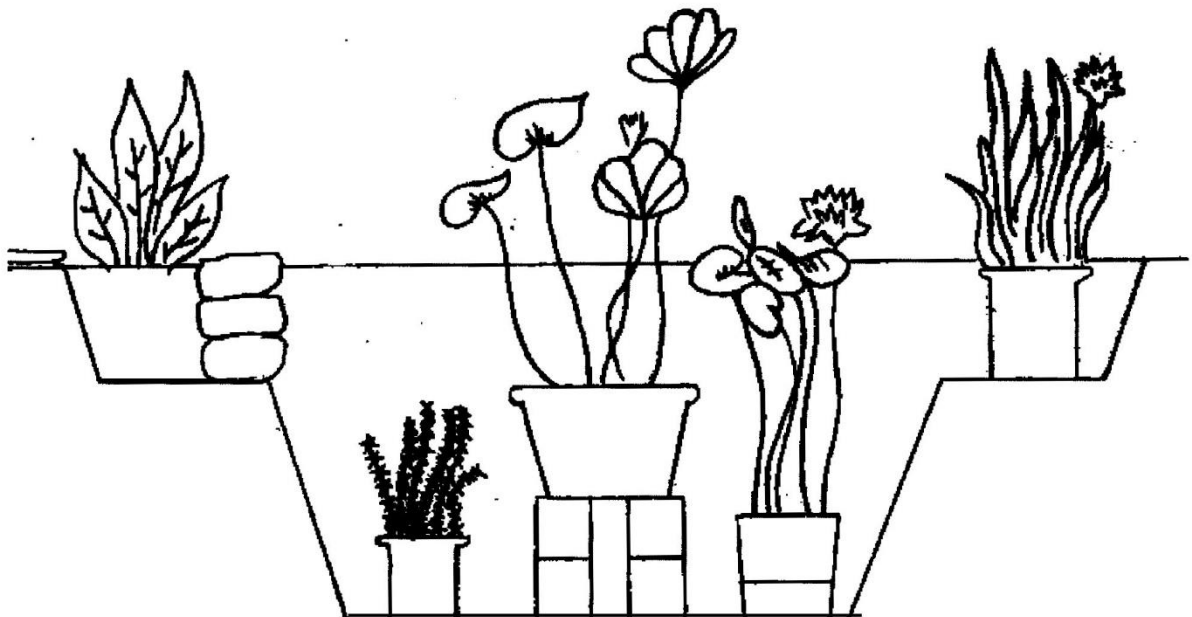

## Hardy Marginal Plants

**Arrow Arum – (Peltandra virginica)** Narrow light green spathes. Dark green arrow-shaped leaves arising from short fleshy roots. Height to 24”, depth 2-6”

**Arrowhead, Giant - (Sagittaria latifolia)** Given plenty of room this plant is most attractive with large, fleshy stems and arrow-shaped leaves. Produces stalks with classic white flowers. Tolerates some shade. Height 18-24 inches, depth 3-5 inches.

**Bloody Dock (Rumex Sanguineus)** Green leaves with deep red veins. Height 12-18”, depth 0-2”

**Bog Bean (Memyanthes trifoliata)** Trailing green foliage with small white flowers. Height 6-12”, depth 0-4”

**Cardinal Flower - (Lobelia cardinalis)** Gorgeous, slender plant with crimson flowering spikes. Height to 36”, depth 0-2 inches.

**Cattail, Dwarf - (Typha laxmannii )** The perfect cattail for the smaller pond. Develops chubby 2 inch catkins in autumn once established. Height 24-30 inches, depth 0-4 inches.

**Cattail, Graceful - (Typha angustifolia)** Has narrow leaves. Height 5-6 feet, depth 0-6 inches.



**Chameleon Plant (Houttoynia cordata variegata)** Multi colored, heart shaped leaves of green white and maroon with small white flowers. Height 12-18”, depth 0-2”

**Clover Four Leaf – (Marsilea quadrifolia)** Solid green leaves 2” in diameter with 4 lobes. Height 12”, depth 0-2”

**Dwarf Variegated Sweet Flag - (Acorus gramineus variegatus)** Pleases even the most discerning. Stripes of green and white on

slender leaves highlights any pool border. Height 12 inches, depth 2-6 inches.

**Houttoynia Cordata – (Houttoynia cordata)** Dark green heart shaped foliage with small white flowers. Height 12-18”, depth 0-2”

**Iris -** Many different varieties of water iris in colors such as blue, yellow, white, purple, and pink. Height 12-36 inches, depth 2-6 inches.

**Lizard's Tail - (Saururus cernuus)** Fragrant white flowers produced on long spikes. Somewhat heart shaped leaves. Height 12-18 inches, depth 0-6 inches.

**Obedient Plant – (Physostegia leptophylla)** Abundant lavender stalks of flowers. Free flowering. Height to 36”, depth 2-6”

**Pickeral, Blue- (Pontederia cordata)** An excellent plant for any pond. Has glossy, green heart-shaped leaves and soft blue flowering spikes during mid-summer. Tolerates some shade. Height 18-36 inches, depth 1-7 inches.

**Pickeral, White –(Pontederia cordata alba)** Shiny, heart-shaped foliage. Large flowering spikes and long blooming season. Height to 36”, depth 2-6”.

**Rush, Corkscrew - (Juncus effusus spiralis)** Thin twisted corkscrew stems. Very unique. Height to 24 inches, depth 2-6 inches.

**Rush Goldstrike – (Juncus effusus “Gold Strike”)** Striking foliage of dark green with yellowish gold vertical striping. Height to 12”, depth 2-4”.

**Rush, Horsetail - (Equisetum hyemale)** Dark green segmented stalks, similar to bamboo. Height to 36 inches, depth 2-6 inches.

**Rush, Zebra - (Scirpus zebrinus)** Vertical stems banded with white rings on the new stems. Ideal for background. Height 24-36 inches, depth 0-4 inches.

**Water Celery Variegated - (Oenanthe javanica “Flamingo”)** Compact leaves similar to those found on celery stalks. Beautifully variegated with pink, white & green. Height to 8”, depth 2-6”.



## Tropical Marginal Plants

### **Blue Bell - (Ruella squarrosa)**

Small bluebell flowers on short green linear foliage. Height to 24 inches, depth 0-2 inches.

**Creeping Primrose - (Jussiaea repens)** These surface creepers bear striking, bright yellow flowers resembling buttercups up to 2 inches in diameter. Rapid growth and glossy green, oval leaves, 1 inch long, distinguish this plant, which may be invasive. Depth 2-12 inches.

### **Papyrus, Giant (Cyperus papyrus)**

Also known as Egyptian Paper Plant. Tall dark green stems topped with many long, gracefully arching hairs. Grows in clumps. Height 48-60 inches, depth 0-4 inches.

### **Papyrus, Dwarf - (Cyperus haspans)**

A mini version of the Papyrus topped with a short tufted ball which is finer and more compact than the standard. Height 24 inches, depth 0-2 inches.

**Papyrus Dwarf Giant King Tut (Papyrus percamenthus)** The look of a giant papyrus without all the height. Height 24-30", depth 0-3"

**Taro, Black Magic- (Colocasia esculenta "Black Magic")** Incredible dusty charcoal black leaves dark burgundy, almost black stems. Height 4 feet. Depth 0-4 inches.

### **Taro, Imperial - (Colocasia antiquorum)**

Its green leaves have an infusion of violet black color in each leaf, every one being slightly different. Royal appearance indeed. Height 24-30 inches, depth 0-4 inches.



Dwarf Giant  
Papyrus

**Umbrella Palm - (Cyperus alternifolius)** 2-4 foot stems with umbrella like leaves. Small white flowers in summer. Likes marshy ground or shallow water and full sun. Grows well indoors.

**Umbrella Palm, Dwarf - (Cyperus alternifolius "gracilis")** The most popular of the umbrellas, due to its diminutive growth habit. The leaves are short like that of the Giant. Use in combination with Taros and Cattails for an array of pleasing textures and heights. Height 24-30 inches, depth 0-2 inches.

**Water Canna** - Available in an array of colors - yellow, orange, red, salmon, variegated foliage - with either bronze or green leaves. Blooms freely throughout the season. Height 3'-5', depth 0"-12"

**Water Poppy - (Hydrocleys nymphoides)** 5 inch yellow flowers. Floriferous. Creates a carpet of green leaves on the water surface. Height 2 inches, depth 2-4 inches.

**Water Hibiscus** - Excellent burgundy colored foliage with red flowers opening in the evening. Height 24-36 inches, depth 0-4 inches.

**Water Snowflake - (Nymphoides indica)** White snowflake shaped flowers throughout the summer. Small round leaves float on the surface of the water. Depth 0-4 inches.



Canna

## Floating Plants

Plants in this group are fascinating and desirable as they grow and thrive by merely floating on the water's surface. The shade they afford restrains algae growth. Roots provide fish spawning beds and newborn protection. These plants grow easily; control by scooping out excess. Treat them as annuals and remove at first frost.

**Frog's Bit – (Limnobium spp.)** Shiny smooth leaf surfaces are supported underneath by thick spongy tissue. Light green undersides show slightly for contrast.

**Water Hyacinth - (Eichhornia crassipes)** Shiny buoyant foliage, lavender blue flowers. Excellent for goldfish breeding.

**Water Lettuce - (Pistia stratiotes)** Also called "Shell Flower". Pale green foliage; feathery roots ideal for spawning.

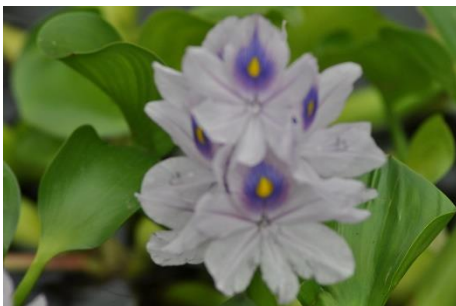

## Submerged Plants

These plants play a vital role in your water garden. They deprive algae of mineral salts and sunlight which are needed by the algae to flourish. They provide oxygen, food, shelter, and a place to spawn for your fish. They also absorb the carbon dioxide given off by the fish. Oxygenators are supplied in bunches of unrooted cuttings which should be anchored in pots filled with soil or sand and topped with gravel to promote growth.

**Hornwort – (Ceratophyllum demersum)** Submerged but unrooted bright feathery green foliage. Easy to grow.

**Rotala – (Rotala rotundifolia)** Pointed short (1/2-3/4" long by 1/8 inch wide) leaves underwater. Pale pink flowers on terminal heads of stems.

**Bacopa – (Bacopa caroliniana)** Slow growing stem plant with oval shaped leaves. The leaves are light green and with sufficient light the top leaves get a bit red.

**Mint – (Mentha aquatica)** Aromatic smooth foliage.

**Red Ludwigia - (Ludwigia mullertii)** Glossy, olive-green leaves above with reddish undersides. The slender stems bear small yellow flowers in the leaf axils. It is a very good submerged oxygenator and tips the water surface with creeping runners.



# Fish

Our fish supply is continuously being restocked with new sizes, colors and varieties of fish. The following is a description of fish that we generally carry. Stop by and pick out your favorites.

## Goldfish Varieties

### Comets

Although colored like regular goldfish, Comets have flowing tails often as long as their bodies. They too are hardy in colder climates and add character to a water garden. A comet grows approximately 1” per year up to 10-12”.

### Sarasa Comets

A Sarasa Comet is a comet variety that has a body that is colored both red and white. Each has a different pattern of the two colors. These fish are hardy to cool climates and can grow to 12 inches at a rate of 1” per year.



### Shubunkins

Shubunkins are a variety of goldfish that are colored a combination of white, blue, gray and red. Shubunkins are typically mottled with two or more of these colors and each pattern is unique. Since they are a comet variety they will grow to 10-12” at a rate of 1” per year.



### Wakin

The Wakin goldfish has a slender body, somewhat similar to a Comet Goldfish, but with a differently shaped tail. The Wakin Goldfish has a more fantail shaped caudal fin, but the fin is not very long. The major colors of the fish are bright red and crisp white, which can form intriguing color patterns. Every Wakin will display an individual color pattern and the fish usually looks most striking when watched from above.

### **Please Be a Responsible Pond Owner**

*Comets and Koi found in most back-yard garden pond are non-native fish. This means they should never be released into the wild. If you have fish that you can no longer keep please try to find a home for them other than the local streams, lakes and ponds.*

*The same goes for plants. Each year more of our favorite aquatic plants are added to the invasive plant list prohibiting us from having them in our back-yard pond. If your plants are too much for your pond please compost them rather than tossing them into local waterways.*



## ***Koi Varieties***

### **Koi**

Koi are considered to be the largest of the pond fish. They are a member of the carp family and can reach lengths of 2 feet or more. They grow quickly when feed a balanced diet when they are young – easily 3” per year. As the koi matures, the growth rate slows down and the color patterns become more stable. These pond fish can easily outgrow a small pond so be sure your pond is large enough and do not over stock when fish are small. The Koi are most known for the vibrant colors on their backs and heads. Each of these color patterns has a Japanese name. Koi can be easily trained, are very friendly, and long lived. Originally bred in Japan, these fish are now being bred in the United States and Israel. Koi can be aggressive in a pond. Due to their growth rate, their appetite for pond plants can leave a new water lily leafless in just a day.



*Blue Ridge Fish Hatchery*



### **Butterfly Koi**

These longfin members of the carp family are a wonderful addition to the water garden. They have the same growth rates, color patterns and life span as their standard fin counterparts. While their body and colors can be the same as found in other koi, their extra-long fins float beautifully through the water.

*Blue Ridge Fish Hatchery*

### ***Stocking Your Pond With Fish***

Stocking of a new pond should be done gradually. Adding too many fish at one time will compromise the quality of the water and may result in fish death. Add no more than 1/3 of the recommended amount of fish at a time over a 3-6 week period. Proper stocking levels depend on the fish (comet vs. koi), volume of water and the amount of filtration just to name a few considerations. New fish should be quarantined before adding to your existing pond fish.



### **EvoFeed Auto Fish Feeder**

The feeder is designed to use pellets from 3-10 mm diameter. We do not recommend the use of sticks, flakes or other shapes of food. The rechargeable lithium battery only needs an overnight charge indoors, to then operate for at least 3 months powered by its own battery, depending of the timer setting. Adapter for charging is included. The feeder will work as normal when adapter is plugged in. evoFeed Automatic is specially designed with a strong motor and extra bottom ventilation over the impeller to prevent the food from clogging. Fixing pegs are included, which makes it easy to place and secure the feeder at the edge of your pond.

\$349.99



# Fish Food

## Blue Ridge Fish Food

### Floating Koi and Goldfish Food

Provides a completely balanced nutritional diet that greatly enhances growth in all koi and goldfish. Contains a special blend of vitamins and minerals that promotes resistance to stress and immunity to diseases. Use large pellets for fish larger than 5" and mini pellets for smaller fish. The blend offers both sizes in one bag. The Cool Water Wheat Germ provides improved digestibility at low temperatures when koi and goldfish's metabolism slows. Feed when water temperatures are below 60 degrees (available in large pellet only).

2 lb \$ 15.99                      5 lb \$28.99                      25 lb \$129.99



### Platinum Pro

Professional, fish meal-based diet formulated for discerning koi keepers that want the very best for their fish. This is a higher protein formula that will provide your koi with exceptional growth, nutrition and coloration. It contains everything needed to keep your fish in top show condition including top quality protein, carbohydrates and amino acids. It contains proven color enhancers Spirulina and Canthaxanthin for superior color enhancement. Also includes Primilac, a probiotic immune stimulant designed to protect koi from sickness and disease.

4.5 lb re-fillable jar \$38.99 (refill price \$29.24)    14 lb bucket \$119.99 (refill price \$89.99)



### Probiotic Plus

Specially formulated with Primilac, Vitamin C and Montmorillonite Clay to boost koi and goldfish immunity, prevent disease and infection, and keep fish happy and healthy. The Probiotic Plus additives provide:

- Increased immunity to bacterial infection, reducing the chances your Koi fall victim to ulcer disease, fin rot and tail rot
- Improved digestion
- Increased growth rates
- Enhanced coloring, including deeper reds and crisper whites
- Essential minerals and trace elements that are typically filtered out of municipal water sources

2 lb \$19.99    5 lb \$38.99



## Koi Krunchies

Ideal for hand feeding goldfish, Koi and other pond fish. High quality natural ingredients. Good source of vitamin C. Wonderful addition to your fish's regular diet. Contains real fruit flavors, and provide a great source of vitamin C, which is linked to proper tissue formation and proper digestion. \$21.99



Thermometers are a must for a pond \$8.99



**Only feed fish as much as they will eat in 5 minutes**  
**A floating fish food is best so that you can see that they are eating it as well as examine the fish as they come to the surface for food.**

**Frequency and the amount of food should vary with water temperatures.**  
**Below 45F – do not feed**  
**45-60F – feed 3-5 times per weekly**  
**60-85F – feed 1-2 times daily**  
**Over 85F – don not feed**

***If you are in doubt about if to feed, it is always best to underfeed rather than overfeed. Overfeeding will result in poor water quality.***

tice

Country Gardens  
(978)948-2124

## Tetra

### Tetra Pond Sticks

This fish food is an economical food easily digested and containing full nutritional values required for all pool and pond fish.

|    |         |     |         |     |         |
|----|---------|-----|---------|-----|---------|
| 1L | \$ 8.99 | 7L  | \$26.99 | 15L | \$54.99 |
| 4L | \$19.99 | 10L | \$97.99 | 25L | \$66.99 |



### Tetra Koi Vibrance

This is a premium color enhancing food which will increase growth and color in all koi.

|    |         |     |         |
|----|---------|-----|---------|
| 1L | \$ 8.99 | 10L | \$45.99 |
| 4L | \$24.99 | 15L | \$61.99 |
| 7L | \$33.99 | 25L | \$42.99 |



### Tetra Growth Food for Koi

Offers a specially balanced diet laden with proteins, vitamins, and minerals to promote growth, color and vitality.

|    |          |    |         |
|----|----------|----|---------|
| 1L | \$ 11.99 | 7L | \$49.99 |
|----|----------|----|---------|

### Tetra Spring and Fall Diet

This wheat germ fish food transitions fish in and out of winter Easily digestible sticks.

|    |        |    |         |
|----|--------|----|---------|
| 1L | \$9.99 | 4L | \$27.99 |
|----|--------|----|---------|



### Tetra Pond Flakes

The "primary meal" for goldfish and small koi. Easily digested enabling your pond water to stay clean and clear.

|    |        |
|----|--------|
| 1L | \$8.99 |
|----|--------|



### Tetra Vacation Food

Slow release feeder block. For all pond fish. Gel based block will not cloud water. For 15-20 Goldfish. use 1 block per 7 day period. For 2-3 large medium koi use 1 block per 7 day period Use multiple blocks for more or larger fish. \$7.99

### Reptomin Food

Floating Food sticks for aquatic turtles, newts and frogs with Calcium and Vitamin C. Easy to digest formula is scientifically formulated with the latest nutritional and manufacturing technologies.

|          |         |
|----------|---------|
| 10.59 oz | \$18.99 |
| 2.64 lb  | \$38.99 |



## Alternative to Manufactured Fish Foods

Changes in your fish's diet will stimulate their appetite and alleviate boredom. However, their main source of food should still be manufactured foods. Use "people food" as snacks only occasionally. Manufactured foods contain the proper balance of vitamins and minerals needed for good fish health

### *Carbohydrates for quick energy*

(keep limited)

- Cheerios
- Wheat Bread
- Potatoes
- Noodles

### *Vitamin C for Color*

- Oranges
- Grapefruit
- Lime
- Melon
- Watermelon

### *Vitamin A,K,C and folic acid*

- Azolla
- Peas
- Spinach
- Leaf Lettuce

### *Protein*

- Insects
- Earthworms
- Shrimp

# Water Clarity and Fish Care

These products only work well if they are used in conjunction with a pump and filter. Keep in mind also that an ecologically balanced pond will need less chemical intervention to keep healthy.

## Water Conditioners

### **Stress Coat**

Stress Coat replaces the natural mucous slime coating on the skin of fish damaged in handling, netting, and times of stress. The aloe vera promotes the healing of damaged skin.

|       |         |          |         |
|-------|---------|----------|---------|
| 16 oz | \$18.99 | 64 oz    | \$49.99 |
| 32 oz | \$31.99 | 1 gallon | \$89.99 |



*For use when adding new water or complete water changes.*

### **Pondmax Detoxmax +**

Immediately removes chlorine, chloramine, and heavy metals that are often present in city water supplies. Also adds a slime coat protectant to the water to help fish heal wounds and abrasions and protect them in times of stress (during water changes & clean outs).

|                 |         |
|-----------------|---------|
| 8 oz Liquid     | \$11.99 |
| 16 oz. Liquid   | \$20.99 |
| 32 oz. Liquid   | \$30.99 |
| 64 oz Liquid    | \$49.99 |
| 1 gallon Liquid | \$89.99 |



*Municipal water supplies are treated to make water safe for humans but it can be toxic to fish. Check with your water department to see which type of chlorination they are using – it can change seasonally.*

### **Aquascape Pond Detox**

Removes and detoxifies chlorine, neutralizes ammonia, detoxifies and chelates copper and heavy metals. Protects and repairs fish mucous membrane (slime coat). Contains Valerian to relax pond fish during clean outs and transport.

|        |         |
|--------|---------|
| 8.5 oz | \$10.99 |
|--------|---------|



*Even if you have well water, you fish will benefit from these water treatments which add their slime coat or remove heavy metals.*

**Dry Ammonia Remover with ChlorAm-X**

Removes & Detoxifies: Ammonia, Chloramines & Chlorine. For fresh & salt water. Suitable for use with fish & shellfish intended for human consumption. 1 oz. of ChlorAm-X will treat 235 gals. of water. It will remove 1 ppm of total ammonia, 3.2 ppm chloramines and 2.0 ppm chlorine.  
1 lb \$32.99 treats 3760 gallons



*For removal of toxins in the water*

**Aquascape Activated Carbon**

Removes discoloration and odors in pond water. Made with bamboo carbon, a sustainable resource with incredible ability to remove discoloration from water. The highly effective carbon also removes chlorines and chloramines from the water which can prove harmful to pond fish. A resealable mesh bag is included for quick and easy application.  
1 bag treats 800 gallons 2.2 lb \$29.99



*It is recommended that a season long bacteria treatment be used to keep toxic ammonia and nitrites from getting high.*

**Polish AC – Activated Carbon**

Removes Ammonia, Nitrite & Nitrate, Removes Tannins, Chlorine & Odor. Polishes Water & Removes Microscopic Debris. Safe For All Aquatic & Domestic Animals. Polish AC™ is bituminous coal that has been exposed to extreme heat which activates the carbon giving it powerful absorbing powers. The billions of pores within the carbon act as hundreds of sponges soaking in many pond pollutants such as, tannins, ammonia, nitrite and nitrate. The result is a polish, healthy pond environment. 5 lbs \$52.99



*Re-test water on a regular basis*

**Control Phosphate to Control Algae**

**Natural Phosphate Binder**

Binds problem causing algae and provides approximately 70 beneficial trace minerals. Buffers pH.  
1 scoop treats 500 gallons  
2 lbs \$23.99  
7 lbs \$69.99



**Alkalinity Booster with Phosphate Binder**

Helps to maintain proper water balance by increasing overall KH, pH and Alkalinity. Phosphate and ammonia free. 1 scoops treats 125 gallons, container treats 5000 gallons  
1.1 lbs. \$19.99

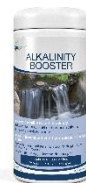

*Phosphate is one of the main nutrients algae needs to survive*

*Reducing phosphate levels can sometimes reduce algae growth*



## Algae Control

### Rock and Waterfall Cleaner Liquid

Commercial strength oxy-based cleaning. Quickly and effectively cleans rocks, waterfalls, water features and fountains. Lifts debris to pond surface where it can be removed by net or skimmer. Simply pour into area with most active water movement for best mixing. Safe for use with fish, birds, pets and wildlife

1 oz treats 300 gallons

32 oz \$19.99

Gallon \$39.99



### Rock and Waterfall Cleaner Dry

Powdered formula brings powerful oxygen based cleaning to ponds. Dry material must contact the debris then lifting it to the pond surface where it can be removed by net or skimmer. Safe for use with fish, birds, pets and wildlife.

1 lb treats 300-400 square feet

2 lb \$21.99

8 lb \$49.99

25 lb \$129.99



### Algaefix

A liquid algae control for use in ornamental fish ponds and water gardens containing fish and plants. Controls filamentous algae, also known as string algae, hair algae or blanketweed. Kills existing algal blooms while helping to control future ones. Not safe for snails.

8oz \$11.99                      64 oz \$54.99

16 oz \$19.99                    1 gallon \$89.99

32 oz \$31.99                    2.5 gallon \$155.99



### Black Pond Dye

Pond dyes help filter out UV rays from the sun. Concentrated formula does not stain or harm fish, plants or other wildlife once dispersed in water (can stain in concentrated form). Gives a more reflective look to the water. 1 oz treats 1000 gallons

16 oz \$14.99



### Pond Block

No measuring – just drop 1 block per 250 gallons into the pond. When it dissolves add another to keep algae from growing.

4 blocks \$14.99

treats 1000 gallons



## String Algae *Chemical Kill*

*For quick kill of string  
algae  
Always provide  
vigorous aeration when  
using products to kill  
algae*

*Avoid using these  
products during high  
temperatures and late  
in the day*

### Fountain Blocks

Controls algae growth in ornamental water fountains. Helps clear cloudy water. Not recommended for use in fountains with live plants or fish. 6 pack \$9.99



Prices subject to change without notice

**Use both algaecides and barley products at the same time to combat string algae**

**Barley Straw**

Floating barley to help reduce string algae as the breakdown occurs throughout the season.  
2 pack \$14.99



**Aquascape Barley Straw Extract**

A pharmaceutical-grade, fermented barley extract. The added enzymes will help reduce pond maintenance by breaking down pond sludge and keeping filter pads cleaner.

8 oz \$19.99  
16 oz \$24.99  
32 oz \$39.99



***Straw bales – last longer***

***Extract – less messy, works quicker***

***Will not kill existing algae, controls growth of new algae***

***A Word on Algae...***

The single biggest pond headache is algae. Algae is a plant. It requires both a nutrient source and sunlight to thrive. Nutrients come from fish waste and excess fish food. Sunlight and shade conditions vary throughout the season. To help control algae keep a check on the following:

- ✓ Provide shade for the pond with floating plants and lilies.
- ✓ Keep your pond from becoming overstocked by culling fish in the spring.
- ✓ Keep your fish feeding to a minimum even though they may seem hungry
- ✓ Provide aeration in the pond paying attention not to create stagnant areas.
- ✓ Keep the pond clean of decaying organic matter such as leaves and plant material. (A spring cleaning will help this greatly.)
- ✓ Use phosphate reducers if necessary
- ✓ Barley can be effective at restricting the growth of string algae but not green water algae.
- ✓ UV Sterilizers will kill off green water algae but not string algae
- ✓ Algaecides are for a quick fix, bacteria are for long term maintenance.
- ✓ Algaefix works well on string algae, re-treatment will be necessary – this is an algaecide.
- ✓ Microbial Algae Clean works well on green water but it takes time – this is a bacteria.
- ✓ A beneficial bacteria must be used when killing algae of any type to break down the dead organic matter.

**Microbial Algae Clean**

This product contains patented bacteria to control green water algae in ponds with live fish and plants. The bacteria help establish and maintain a clean pond, free of algae. They also help improve dissolved oxygen levels and reduce noxious odors from the pond.

- Biological inhibitor of green water algae.
- Promotes a cleaner pond environment.
- Eliminates troublesome organic sludge and debris.
- Will not harm live plants or fish.

16 oz \$21.99



***For Green Water***  
***Biological Control***

***May take up to 3 weeks to see results***  
***Continue to use throughout season***

## Flocculants



### **Water Clarifier**

Concentrated formula clears murky water. Attracts suspended particles together allowing them to settle out of the water column. Best when used with a beneficial bacteria to break down the debris. Great for use after rainfall of anytime pond is stirred up. 1 oz treats 1000 gallons

|        |         |
|--------|---------|
| 16 oz  | \$15.99 |
| 32 oz  | \$21.99 |
| Gallon | \$54.99 |

### **Simply Clear**

A bacterial based pond clarifier that quickly clears murky, cloudy water and keeps it clean and clear through natural bacterial action. This triple action formula acts fast – clears pond water and breaks down sludge and offers a long term solution to un-clear pond water.

|       |         |
|-------|---------|
| 16 oz | \$21.99 |
| 32 oz | \$39.99 |



### **Aquascape Rapid Clear**

Clears cloudy pond water by clumping suspended debris. This will quickly help to provide clear pond water conditions and allow particulate to be captured and removed from the pond. Rapid Clear Flocculant is safe for fish, plants, pets, and wildlife. 1 pump treats 100 gallons  
8 oz. \$15.99



### **Pure Pond Bomb**

Beneficial bacteria. Rather than weekly treatments, drop the entire Pond Bomb into the pond to improve water quality. Can last up to 30 days depending on the organic debris in the pond.

|                              |         |
|------------------------------|---------|
| For ponds up to 5000 gallons | \$26.99 |
| For small ponds Mini Balls   | \$21.99 |



***Flocculants  
clump particles  
suspended in the water  
column and drops them  
to the bottom or into  
the filter.***

***Can sometimes help  
with green water  
particles***

***Use bacteria to break down  
organic matter that  
accumulates on the bottom  
of the pond  
See Dry Biological  
Bacteria  
pages 58-59***

***Regular maintenance of a pond is the best way to avoid both water clarity and water quality issues. We recommend a bacteria treatment and algae control at least bi-weekly during the summer months as well as seasonal pond cleaning.***

Country Gardens  
(978)948-2124

**Liquid Biological Bacteria**



**Easy Pro All Season Bacteria**

Designed to work in spring, summer and fall on removing ammonia, nitrates, phosphates, sludge and improving water clarity in water gardens and koi ponds. This high quality bacteria product will give you all the benefits without the smell. This liquid pond bacteria contains a unique formulation of bacteria that will remain effective in a wider variety of water temperatures, eliminating the need for different bacteria in different seasons.

Dosage rate: 2 ounces per 1000 gallons

- 16 oz \$15.99
- 32 oz \$21.99
- 1 gallon \$69.99



**UltraClear Clarifier**

Improves clarity, cleans the water, reduces organic build-up, and removes odors. UltraClear is the environmentally friendly way to beautify your ponds and fountains. Works naturally and actually benefits

the environment. 100% safe for fish, wildlife, and turf.

- 12 oz \$14.99
- 32 oz \$24.99

**Nite-Out II**

This specialized bacterial additive rapidly breaks down nitrogen compounds. Establishes and maintains the necessary bacterial populations required to efficiently process toxic ammonia to nitrite and then to nitrate. Nite-Out II™ acts within a day or two to lower ammonia nitrogen and nitrite nitrogen levels naturally. The microorganisms are able to use carbon dioxide as the sole source of carbon, and are slow-growing. 16 oz treats up to 960 gallons.

16 oz \$21.99

**Pure + Filter Starter Gel**

Live concentrated bacteria culture for use in new pond filters. The gel based solution will stick to the filter media allowing the nitrifying bacteria to rapidly colonize your filter.

Treats 2600 gallons  
1 liter \$45.99

*Jump Start your pond  
in the spring with  
biological bacteria.*

*Use these nitrifying  
bacteria to keep  
ammonia and nitrite  
levels in check during  
the season*



| Product               | Season         | Description            | Price                         |
|-----------------------|----------------|------------------------|-------------------------------|
| MicrobeLift PL        | Spring, Summer | For clear ponds        | \$21.99 pint<br>\$34.99 quart |
| Spring/Summer Cleaner | Spring, Summer | Removes twigs & leaves | \$34.99                       |
| Autumn Prep           | Fall, Winter   | Winterization of pond  | \$39.99                       |





## Dry Biological Bacteria

### Sludger Remover Bacteria

This unique formulation is produced using a “no mess” powder in water soluble packets which immediately begins to dissolve upon contact with water. Reduces toxic ammonia and nitrite as well as murky water caused by organic waste (sludge) on the bottom of the pond. Ideal for use with All Season Bacteria.

1 packet treats 1000 gallons

12 count \$18.99

24 count \$31.99



### Pond Zyme Sludge Destroyer

This enzymatic pond cleaner breaks down fish waste, uneaten food, and dead vegetation and converts them into non-toxic inert materials. It dissolves away hard to clean wasters that accumulate in the filtration system. It reduces the "biological oxygen demand" thus making more dissolved oxygen available for fish. Helps to

maintain good water quality to minimize stress to fish and plants.

8 oz \$19.99

1 lb \$35.99

### Muck Digester Tabs

The UltraClear Muck digester Tab weighs one ounce and is roughly the size of a golf ball. They are easy to distribute over the pond surface. Randomly toss them over the surface and they sink to the bottom of the pond where they begin slowly releasing a combination of 9 strains of beneficial bacteria into the pond. The tab completely dissolves in 8 hours. Each tab contains 100% safe, natural ingredients. No harmful chemicals are used. Designed to be used in cold water as well as warm water. The tabs are effective in both the anoxic zone on the pond bottom as well in the more oxygenated areas. 1 tab treats 1000 gallons

6 tabs \$19.99

2 lbs \$56.99

4 lbs \$102.99



*Dry bacteria should be used on a regular basis all season long*

*Breaks down organics in the pond including dead algae and decaying plant material*

*For Larger Ponds try*



### Pond Vive

The natural, biological way to revive your pond. This special blend of bacteria is designed to reduce sludge buildup, eliminate pond odors, improve water clarity, reduce oxygen demand, eliminate excess nutrients. Great for larger ponds. Pre-measured water soluble packets you just toss in. 2 packets treats ¼ acre new pond for 2 weeks, use 3 packets every 2 weeks for older ponds.

10 lb pail (20 packets) \$149.99

Country Gardens  
(978)948-2124

### Aqua Defend

Combines 3 powerful ingredients into one easy to use treatment. It contains a proprietary blend of all natural bacteria, enzymes and ingredients to buffer pond water and help keep rocks and waterfalls clean!

- ✓ Bacteria blend is especially effective at breaking down waste and sludge build-up
- ✓ Additive to help prevent build-up on rocks, waterfalls and streams \*
- ✓ Additive to bind phosphates, buffer pH and help settling of particles.

2 oz treats 1000 gallons  
1 lb \$29.99  
2 lb \$54.99  
5 lb \$89.99

\*when rock, waterfalls and streams need a more thorough cleaning use Rock and Waterfall Cleaner



### Cool Water Bacteria



#### Winter Blend Bacteria

Specifically formulated for fall-winter-spring treatment of your pond. Its probiotic formulation of select beneficial bacteria ensures your pond has the required bacteria to maintain a clean pond & healthy fish during the colder months. Start using when water temperature falls below 55 degrees F. Use 1 oz per 1000 gallons of water. \$35.99

#### Aquascape Cold Water Bacteria

Contains 7 pure strains of concentrated beneficial bacteria that go to work quickly cleaning and balancing your pond, works at temperatures below 50F or 10C.  
250 ml treats up to 5000 gallons \$14.99  
500 ml treats up to 10,000 gallons \$24.99



#### Microbelift Autumn Winter Prep

Helps accelerate the decomposition of leaves, sediment and other organic matter during the fall and winter months. MICROBELIFT/AWP will also jump start your pond to a healthier environment in the spring. Liquid and dry packet combination. \$39.99



*Switch to Cold Water Bacteria during spring and fall for best results at breaking down organics*

## **Fish Medications**

***A veterinarian should be consulted to determine what type of infection you have in the pond before treating a pond. Mixing medications or overmedicating can do more harm than good in a pond.  
Good Water Quality = Healthy Pond***

### **Pondmax ParaMax**

A broad spectrum treatment for a variety of parasites, bacteria and fungus including anchorworm, fish lice, flukes, ichthyophthirius (Ick), trichodinella, costia and chilodonella.

1 oz per 60 gallons. Use 3 times over 2 week period.

16 oz.liquid \$29.99

32 oz liquid \$59.99

Gallon \$219.99



### **Parasite & Ich Treatment**

Used for treatments of external protozoan parasites including ich, costia, and trichodinella. 1 bottle treats 1250 gallons

8 oz \$18.99



### **Praziquantel Treatment**

Used for the treatments of external and internal parasite – flukes, flatworms and tapeworms. 1 bottle treats 1250 gallons \$32.99

### **Pondmax MediMax**



Excellent for controlling gill diseases in pond and aquarium fish. Bacterial diseases generally result from fish stress due to adverse water quality conditions (pH, oxygen or temperature problems), habitat clean-outs, untreated abrasions or predators. ½ oz per 300 gallons. Use 3 times over 2 week period. 8 oz granular \$20.99

### **Melafix**

All natural fish medication. Effective antibacterial remedy for pond fish. Also causes rapid repair of damaged fish tissue. Treats ulcers and open wounds.

16 oz \$24.99

64 oz. \$79.99



### **Pimafix**



The all natural antifungal remedy for koi and goldfish. Broad spectrum of treatment that effectively clear fungal infections. Can be used in combination with Melafix to treat a wide range of fungal and bacterial infections. Naturally. 16 oz \$24.99 64 oz \$79.99

***Remember there are bacteria and parasites existing in most pond systems and any stress of the fish will weaken the immune system and give these pathogens a “way in”.***

***Check your water quality to be sure pH, Ammonia, and Nitrite are at healthy levels to prevent additional stress when treating for infection.***

***For Parasitic Infections a scraping of the slime coat of the fish should be examined under a microscope to determine the presence of parasites.***

**Remember when using Medications in the water that some of your nitrifying bacteria may be killed off and oxygen may be depleted. Keep a close check on ammonia and nitrite levels as well as dissolved oxygen.**

### **Water Enhancers for Fish**

#### **UltraClear Koi Clay**

Benefits your Koi & pond fish in several ways. It provides valuable trace minerals including calcium, magnesium and other trace elements for improved bone and scale growth, blood clotting and reduced loss of sodium and potassium from fish blood. It contains essential silica for removing harmful toxins and heavy metals. UltraClear Koi Clay also helps create an ideal habitat on the pond bottom for Koi fish to thrive and flourish. UltraClear Koi Clay is 100% Bentonite Clay. The geometrically unique surface of the Bentonite Clay and the size of the particles is critical for bonding with and absorbing toxins such as heavy metals and pesticides that may enter the pond habitat. UltraClear Koi Clay helps to maintain a clear, high quality water environment for your Koi or gold fish in your pond. Add 2 tablespoons per 1000 gallons each week. Increase frequency if the problem persists or the load increases.

4 lb \$38.99



#### **Easy Pro Pond Salt**

99% pure-made from evaporated seawater. Additional electrolytes. Reduces fish stress and improves disease recovery. Enhances fish's natural slime coat.

Use 1-2 lbs per 100 gallons

10# \$20.99

20# \$34.99

50# \$69.99



*Salt is beneficial to fish but not well received by plants at heavy doses.*

#### **Pond Care Pond Salt**

An all-natural sea salt that replaces electrolytes which fish lose in times of stress, including potassium, sodium, chloride, calcium, & magnesium. All of these are essential for the uptake of oxygen & the release of carbon dioxide & ammonia. Made from evaporated sea water (not just a table or rock salt). Helps eliminate the toxic effects of nitrite. Improves fish gill function.

4.4 lbs \$10.99



*Once added to the pond salt will remain until it is pumped out – it will not evaporate out with water.*

*Many de-chlorinators provide enhancements to water for the benefit of the fish as well. Pondmax Detoxmax, Stress Coat, and Aquascape Pond Detox all contain additives to replace the natural mucous slime coat of the fish.*



# Accessories

## Test Kits

A helpful way to prevent fish disease or mortality is to test your pond water. Pond fish are especially effected by pH and ammonia levels of the water. KH/Alkalinity has a direct relationship on how well your pond is buffered against pH swings and crashes.



| API Test Kits     |         |
|-------------------|---------|
| pH                | \$8.99  |
| Ammonia           | \$19.99 |
| Nitrite           | \$9.99  |
| KH                | \$9.99  |
| Multi Test Strips | \$18.99 |

KH/Alkalinity Test Kit - \$19.99

Liquid pH Lower 32 oz \$19.99

Liquid pH Higher 32 oz \$19.99

Alkalinity Booster \$19.99

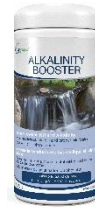

**Many factors contribute to the fluctuation of water parameters such as pH, Ammonia and Nitrite just to name a few. Test your water periodically to be sure it is safe for fish and plants while also balanced to enhance water clarity.**

**Important tests are those for pH and Ammonia. Pond fish prefer a pH of between 7.0 and 8.0. They can adjust to a lower or higher pH. However, you need to be aware of your pH level when introducing new fish to the pond. Ammonia can be highly toxic to pond fish. If your pond is overloaded with fish or you are overfeeding your fish, the ammonia levels may be getting high. The best way to combat high ammonia is by partial water changes when you notice the levels beginning to rise, then locate and relieve the problem.**

## For Plants

### Pondtabbs Tablets

Aquatic plant food. Feed your aquatic plants to maximize beauty and get the most out of your plant investment. These plant food tablets were formulated to feed all pond plants while not releasing chemicals into the water that would encourage algae growth.

20 tablets \$ 8.99

60 tablets \$18.99

300 tablets \$79.99



Country Gardens  
(978)948-2124

**Organic Top Soil**

A heavy mix of soil ideal for aquatic plants.  
\$9.99

**Tips for Growing Water Lilies**  
*6 hours of sunlight or more*  
*Fertilizer every 2-4 weeks during summer months*  
*Trim dead foliage & flowers*  
*Repot every 2-3 years*

**Lily & Lotus Pots**

Water lilies and lotus grow best in larger containers.

- Round 16"x7" \$18.99
- Round 15"x8.5" \$13.99
- Round 19.5"x9.5" \$24.99



**Mesh Plant Containers**

These black baskets are excellent for planting aquatics since they allow the roots to breath and reach the water easily. The black growing pots contain no holes in the bottom and are excellent for lilies and lotus in the larger sizes.

Baskets

- Medium Round (8") \$4.99
- Large Round (10") \$4.99
- Large Square (12") \$7.99
- Contour (18"x7") \$7.99



Floats for Baskets

***Best used with low growing marginals***

- For 8" Round \$19.99
- For 10" Round \$32.99
- For 9" Square \$32.99
- For 12" Square \$49.99
- For Contour \$34.99



**Floating Plant Bags**

No shelves in the pond – no problem. These floating plant bags will help keep shallow water plants close to the surface in the pond .

- 10" \$19.99
- 14" \$24.99
- 18" \$32.99



**Pond Nets**

| Model                                       | Bag Shape          | Handle Length    | Price   |
|---|--------------------|------------------|---------|
| Pond Net<br>(loose black mesh)              | Rectangle 12"x7"   | Telescope to 63" | \$21.99 |
| Skimming Net<br>(tight white mesh)          | Rectangle 12"x7"   | Telescope to 63" | \$21.99 |
| Large Pond Net<br>(loose black mesh)        | Triangle           | Telescope to 63" | \$37.99 |
| Large Skimming Net<br>(tight white mesh)    | Triangle           | Telescope to 63" | \$37.99 |
| Fish Net (loose black mesh)                 | Round 22" diameter | Telescope to 69" | \$46.99 |
| Professional Pond Net<br>(loose black mesh) | Triangle 20"x23"   | 40"              | \$79.99 |



**For Fall & Winter**

**Aquascape Protective Pond Netting**  
Keeps predators out while catching leaves and falling debris before they enter the pond. The reusable netting is easy to install and made of quality woven poly material that resists tearing. Each net comes complete with landscape stakes, making it simple and easy to cover your water feature.

- 7'x10' \$15.99
- 14'x20' \$29.99
- 28'x30' \$69.99



**Easy Pro Pond Netting**

Strong black netting is protected with a UV coating to last. Includes stakes.

- 15'x15' \$22.99
- 20'x20' \$44.99
- 20'x30' \$59.99



**Easy Pro Deluxe Pond Cover Tent**

Complete pond and garden protection for leaves and unwanted pests! Simple two person assembly can be completed and installed in just a few minutes. Strong 3/8" nylon black mesh netting will last for years. Dark mesh allows for easy viewing of pond with tent in place.

- 8'x10' \$149.99
- 10'x14' \$199.99
- 13'x17' \$289.99



**Dalen Netting**

This black netting provides coverage for your pond from wildlife. Use it in the fall to catch the falling autumn leaves from entering into the pond. Tent it over the pond so the leaves roll off to the sides. Be sure to remove your net before the first snowfall to keep it from sinking into the pond.

- 7'x10' \$13.99
- 14'x14' \$22.99
- 28'x28' \$66.99
- 28'x45' \$84.99
- 14'x45' \$44.99



Country Gardens  
(978)948-2124

### Microbelift Autumn Winter Prep

Helps accelerate the decomposition of leaves, sediment and other organic matter during the fall and winter months. MICROBE-LIFT/AWP will also jump start your pond to a healthier environment in the spring. Liquid and dry packet combination. \$39.99



### Winter Blend Bacteria

Specifically formulated for fall-winter-spring treatment of your pond. Its probiotic formulation of select beneficial bacteria ensures your pond has the required bacteria to maintain a clean pond & healthy fish during the colder months. Start using when water temperature falls below 55 degrees F. Use 1 oz per 1000 gallons of water. \$35.99

### Aquascape Cold Water Bacteria

Contains 7 pure strains of concentrated beneficial bacteria that go to work quickly cleaning and balancing your ornamental pond, works at temperatures below 50F or 10C. Aquascape Cold Water Beneficial Bacteria contains a specific combination of bacteria that are most effective at doing two jobs- reducing organic material such as leaves and pond sludge and reducing ammonia, nitrite and excess nutrient such as phosphate that are known to cause poor water quality and unsightly water conditions.

250 ml treats up to 5000 gallons \$14.99

500 ml treats up to 10,000 gallons \$24.99



### Aquascape Smart Pond Thermometer

This specially designed pond thermometer is easy to connect to your smartphone or tablet, allowing you to easily check the temperature of your pond or water feature using the [Aquascape Smart Control App](#). Use the immediate and accurate temperature data to adjust fish feeding schedules, change water treatments, and more. The product also includes an integrated display panel for monitoring temperature without the use of a tablet or smartphone. The durable, spherical design is weighted to sink and built to last in all weather conditions, capturing temperatures between -20°F and 120°F (-28°C and 48°C). Compatible with iPhone and Android operating systems and adequate wireless coverage is required (2.4 GHz supported). 3 year limited warranty. \$89.99



### Winter Tips

- *Stop feeding fish when water temperature drops below 50F*
- *Trim and remove dead foliage on plants*
- *Add fall bacteria to breakdown organic matter*
- *Remove the pond net before the snow falls*
- *Wait 2 weeks after last fish feeding before shutting down pumps and filters*
- *Start Aerator immediately after pump is shut off and run continually*
- *Turn on De-Icer when aerator is no longer keeping adequate hole in ice*



### CAS Aeration Kits

Supplying adequate oxygen levels and circulation during hot summer months and de-icing during freezing months is critical for pond and fish care. CAS Pond Aeration Kits provide quiet and energy efficient aeration of aquariums, water gardens and koi ponds, making them the perfect choice. Continuous duty compressor with 6' power cord. Operates up to 4' deep

CAS1 includes 25' tubing, 1 diffuser \$56.99

CAS2 includes 2-25' tubing, 2 diffusers \$76.99

### Teton Aeration Kit



Can be added to an existing pond or a new pond. Every aeration kit comes with an air pump, air tubing and air stones. The air pump is installed on the side of the pond, then the air line can be very easily installed

over the edge of the pond sides to supply air to the air stone below the water surface. 2 year warranty. XA25K for ponds up to 2500 gallons. \$209.99

Pump Only \$149.99

Replacement Air Stone 5" \$19.99

### KLC Koi Pond Aeration Kit

Give your pond some Koi Loving Care! Ensure adequate oxygen and circulation during hot summer months and de-icing capability during freezing months. Dual linear diaphragm compressor provides maximum air output, quiet and energy efficient, safe for fish, pets and family with no electricity in the water. 3 year limited warranty. Includes compressor with 6' power cord, rubber membrane diffuser, connectors and 3/8" Quick Sink tubing.

LA1 \$274.99

Replacement Diaphragm \$37.99

### Aquascape Pond Air 2

Extremely energy-efficient, quiet, simple to use and maintain, comes complete with winter resistant air line, preassembled check valves and weighted air stones. \$79.99

Replacement Air Disc \$12.99

Rebuild Kit \$25.99



### Aquascape Pond Air Pro 60

Aquascape professional-grade aeration system is designed to help improve water circulation and increase oxygen throughout the pond. Comes complete with a weather-proof, outdoor-rated, energy-efficient 45-watt air pump. High volume 2.1 CFM of air. For ponds up to 10,000 gallons. Includes one large 8-inch diameter aeration disc and 30-feet of 3/8" braided aeration tubing. \$399.99



*We recommend a combination of air pump and de-icer during the winter months. In this area, typically an aeration will only keep a hole open in the ice in temperatures above 15F.*



*Keep your Aerator running continually but the de-icer can be turned on and off (or kept on a timer) as needed to provide an adequate opening in the ice.*



### **De-Icer Maintenance**

De-icers should be cleaned and stored for the spring and summer. Examine for corrosion. Before putting in the pond for the winter, test the de-icer by putting it into a freezer 2-3 hours. Take out and immediately plug into GFCI protected outlet. The light on top of the de-icer should turn on and it should not trip the GFCI. Check again when it is placed in the water to be sure the GFCI is not tripped. Tripping indicates seals broken down and you should replace de-icer. Please be sure to always plug pond items into a GFCI outlet.

#### **Laguna 315 watt De-Icer**

Safe for plastic and liner ponds. Includes a highly visible LED light that indicates when it is on. Thermostatically controlled on/off feature saves energy. 315 watts, 22' power cord \$139.99



#### **Laguna 500 watt Power Heat**

Maintain a vent hole at the pond surface for proper gas exchange. Stainless Steel housing for even heat distribution and corrosion resistance. Safe for plastic and liner ponds, will not harm fish or plants. Dual zone integrated thermostats. LED power indicator on top lets you know unit is on and when it is heating. \$199.99



#### **Aquascape 300 watt Heater/De-Icer**

Keeps a small hole in the ice during winter months. Helps increase pond oxygen levels. Stainless steel construction prevents corrosion and cracking. Integrated thermostat saves electricity. Built-in LED light indicates when heater is in use. 22' cord. 3 year warranty. \$179.99



#### **Aquascape Smart Control Plug**

Allows you to control and monitor outdoor electronics from your anywhere using your Smart phone or Tablet. The plug features three outlets so you can control three products simultaneously. Adequate wireless coverage is required (2.4 GHz supported). 3-year limited warranty \$69.99



*Make regular checks on your de-icer and aerator throughout the winter to be sure they are working properly*

*Each pond differs based on fish load and level of organic matter as to how large an opening is needed and how long the hole can close before fish health is compromised. Keep in mind that as your pond matures, additional winter care may be needed. Larger or more fish and heavily planted ponds need a larger hole in the ice for better gas exchange.*



## Pond Maintenance

### **Aquascape Smart Pond Thermometer**

This specially designed pond thermometer is easy to connect to your smartphone or tablet, allowing you to easily check the temperature of your pond or water feature using the Aquascape Smart Control App. Use the immediate and accurate temperature data to adjust fish feeding schedules, change water treatments, and more. The product also includes an integrated display panel for monitoring temperature without the use of a tablet or smartphone. The durable, spherical design is weighted to sink and built to last in all weather conditions, capturing temperatures between -20°F and 120°F (-28°C and 48°C). Compatible with iPhone and Android operating systems and adequate wireless coverage is required (2.4 GHz supported). 3 year limited warranty. \$89.99



### **Floating Thermometer**

The most important tool you should have for your pond if you have fish. Feeding and activity of the fish are determined by pond temperature. Easy to read Fahrenheit and Celsius scales. Fluorescent marking. \$8.99

### **Mosquito Dunks**

Safe to pets, children and the environment. Made with B.T. a naturally occurring biological organism which kill mosquito larvae by feeding on it before it becomes a biting adult. Will continue to kill mosquito larvae for 30 days or more. Each dunk covers 100 sq. Ft. of water surface. Use the Mosquito bits for a quick kill without lasting effects.

- 6/card \$14.99
- 2/card \$11.99
- Mosquito Bits 8 oz \$13.99
- Mosquito Bits 32 oz \$19.99



## Pond Construction

### **Waterfall Foam**

Use foam to help control water direction in your waterfall. This foam will set up a barrier between your pond liner and stone to move the water over or between rock in the waterfall.

- Aquascape Single Use Can 12 oz \$19.99
- Easy Pro Single Use Can 20 oz \$27.99
- Multi Use Can \$39.99 (must be used with a foam gun)
- Foam Gun Cleaner \$39.99
- Economy Foam Gun \$72.99



### **Bulkhead Fittings**

Need to cut a hole for plumbing. Bulkhead fitting provided a threaded through liner fitting for attaching pvc fittings.

- 1 ¼" \$15.99      2" \$21.99      4" \$129.99
- 1 ½" \$17.99      3" \$49.99



**Seaming Liner**

**Quick Prime Plus & Liner Tape**

A must when joining two pieces of liner. Use the QuickPrime with the Liner Tape for best results.

Quart LVOC- \$129.99

One Sided Tape – 6” wide \$4.99 per foot

Double Side Tape – 3” wide \$3.99 per foot



**Terminating Liner at a Hard Surface**

Adhering liner to a flat surface can be done using a termination bar. The bar has pre-punched holes in 4” increments. Use every hole when terminating underwater, every other hole above water.

10” Aluminum Bar \$35.99

Concrete Anchors \$2.29 each

**Ball Valve**

Control the flow of pumps or just add back pressure to your pump by installing a ball valve within the pvc tubing. Socket fittings allow you to glue pvc for easy installation.

2” \$19.99

1.5” \$15.99

1.25” \$15.99 (other sizes available)



**Flexible Rubber Coupling**

Rubber coupling with stainless steel clamps on both ends for easy on and off. Use any place you regularly disconnect you pvc pipe. The elbow is great for use in a skimmer box.

|           | Straight Coupling                   | Elbow   |
|-----------|-------------------------------------|---------|
| 1 ½”      | \$8.99                              | \$8.99  |
| 2”        | \$10.99                             | \$10.99 |
| 1 ½” / 2” | \$19.99 for joining 1 ½” to 2” pipe |         |



**Diverters & Fountains**

**Triton 3-Way Diverter**

Manifold designed exclusively for pond-free fountain installations. The 1 ½” inlet will not restrict the flow of water into the manifold, thereby delivering maximum volume to each of the three outlets. True “ball” style valves with removable handles enable small flow adjustment to be made to each outlet independently. The compact design makes it a perfect fit for installation in all pump vaults and fountain basins.  
\$46.99



**Easy Pro Statuary Splitter**

½” and ¾” stepped barbed fitting on inlet and outlet. Individual flow control valve on each line. \$14.99





**Pondmaster Diverter Valves**

Comes with female coupling, threaded outlets and diverter valve

| Model  | Fits Pumps (GPH) | Thread Size | Price   |
|--------|------------------|-------------|---------|
| #02099 | 250-700          | 1/2" male   | \$19.99 |
| #02090 | 950-1800         | 3/4" male   | \$21.99 |
| #02092 | 2400-3600        | 1" male     | \$21.99 |



**Water Movement**

We have a variety of spitters that can be added to a pump to create water circulation that are decorative to the pond.

- Lazy Frog on Lily Pad \$79.99
- Fairy Planter \$99.99
- Turtle on Log \$79.99
- Double Turtle on Log \$99.99
- Silly Snail \$109.99
- Jazz Frog \$109.99
- Toucan Spitter \$149.99
- Koi Spitter \$59.99



**TidalWave Fountain Heads**

Compatible with the Atlantic MD Pumps, these versatile fountain heads pivot to make leveling easy, telescope to adjustable heights and feature four different spray patterns to choose from.

- MDFH2575 – for use with MD250-MD750 \$21.99  
Minimum height 12" – maximum height 18"
- MDFH1020 - for use with MD1000-MD2000 \$30.99  
Minimum height 15" – maximum height 22"



Bell Blossom Daisy Trumpet



# Rain Harvesting Kit

\$2499.99

## Kit includes:

- ✓ Submersible on-demand pump
- ✓ Clean Rain Ultra Downspout Diverter
- ✓ Rain Harvesting Pump Vault
- ✓ 45 mil EPDM pond liner 15'x20'
- ✓ Heavy duty underlayment 12'x25' 2 pieces
- ✓ Tank Gauge
- ✓ 16 Eco-Blox
- ✓ Fittings



## TYPICAL INSTALLATION:

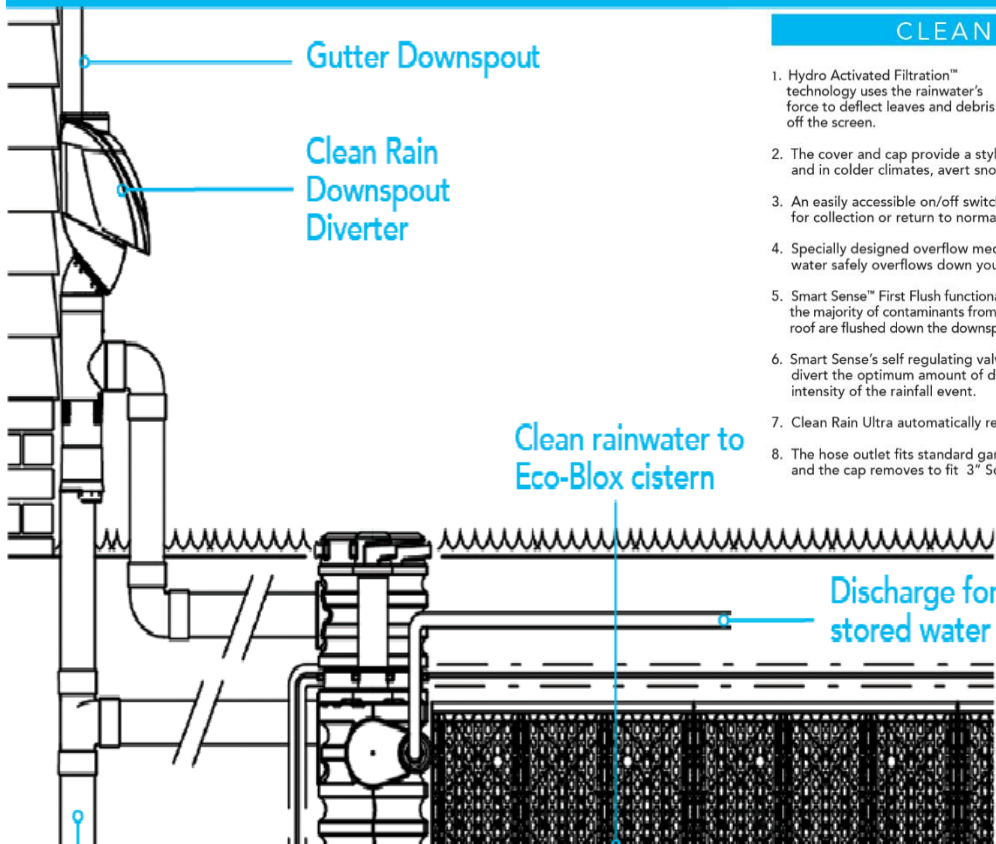

## CLEAN RAIN FEATURES:

1. Hydro Activated Filtration™ technology uses the rainwater's force to deflect leaves and debris off the screen.
2. The cover and cap provide a stylish, integrated finish and in colder climates, avert snow and ice blockage.
3. An easily accessible on/off switch to direct your rainwater for collection or return to normal downspout functioning.
4. Specially designed overflow mechanism ensures excess water safely overflows down your downspout.
5. Smart Sense™ First Flush functionality ensures the majority of contaminants from the roof are flushed down the downspout.
6. Smart Sense's self regulating valve automatically adjusts to divert the optimum amount of dirty rainwater based on the intensity of the rainfall event.
7. Clean Rain Ultra automatically resets itself after every rainfall.
8. The hose outlet fits standard garden, pool and sump hoses and the cap removes to fit 3" Schedule 40 pipe.

hydro activated  
FILTRATION TECHNOLOGY

smart sense  
FIRST FLUSH



## How it works:

Rainwater is intercepted in the downspout by the Clean Rain Ultra Downspout Diverter, which removes leaves, screens dirt and debris from the water and allows the first 10 to 15 gallons of rain to flush the roof clean. As the first flush passes through, a stack of washers swells, tripping a valve and diverting clean water to the reservoir for future use.

## **Earth Bottom Lake and Pond**

The “engine” that drives everything within a body of water is the presence of oxygen in proper levels. A pond’s condition deteriorates when its bottom environment cannot support aquatic life. The bottom is where the most oxygen is consumed and the farthest from the surface where it is replenished. Without adequate oxygen at the bottom, beneficial bacteria do not break down the organic waste. This results in increased layers of sediment (muck) along the pond bottom. Simply put, without oxygen a pond cannot clean itself!

### **Aeration**

Installing aeration to your pond or lake is the single most valuable water management and water maintenance strategy a person can implement. The movement of oxygenated water from the bottom up provides a long list of benefits to your water. Pond and lakes age – the older a body of water, the higher the organic muck load and the higher total oxygen demand (TOD). Aeration can stop and even reverse, the effects of aging. Oxygen is the “fuel for the engine” that drives all biological and chemical process in your pond.

### **Beneficial Bacteria**

Adding bacteria on a regular basis will improve water quality and clarity, reduce odors, improve oxygen levels and create a better environment for fish and other aquatic life. Combining aeration with additional bacteria is a proven method of reversing the aging process mentioned above. Supplementing your pond with natural bacteria to help reduce sludge build-up is a widely used practice

### **Weed and Algae Controls**

There are wide variety of treatment product available to safely control aquatic weeds and algae in lakes and ponds. The use of these products is a good short term solution to a problem, however, to gain long term control you should look at the overall ecosystem and determine the source of the problem. Often aeration and/or the use of bacteria will greatly improve the system.

### **Aeration Kits for Shallow Ponds**

For ponds 7’ deep or less, these linear powered aeration systems are a great choice. Choose from either single or double diffuser system. Single diffuser is ideal for round or regular shaped ponds. Use the dual diffuser system for long and narrow or irregular shaped ponds.

- Extremely energy efficient
- Very quiet operation
- Long lasting, oil free design
- Weather resistant enclosures – can be used outdoors, for maximum longevity use additional protection from elements
- Includes self weighted diffuser for easy installation
- Includes quick sink tubing for easy installation



PA6SWN – single diffuser – 50’ ½” quick sink tubing – aerates up to 3/8 acre - \$519.99

PA8SWN – dual diffusers - 100’ ½” quick sink tubing – aerates up to 3/4 acre - \$799.99



**Easy Pro PA34 Aeration System**

¼ hp Stratus SRC Gen 2 compressor with 2 year warranty. Outlet assembly has pressure relief. Kit includes 100’ of 3/8” weighted tubing, one rubber membrane diffuser assembly, and compressor. Low operation costs. Requires weather protection for compressor. \$879.99



The deeper the air diffuser is located, the more “boiling action” it will create and a larger area will be aerated. Single diffuser best for round ponds.

- For ponds 5’-8’ deep – will aerate up to ¼ acre
- For ponds 8’-12’ deep – will aerate up to ½ acre
- For ponds 12’-16’ deep – will aerate up to 1 acre

**Easy Pro PA34-2 Aeration System**

¼ hp Stratus SRC Gen 2 compressor with 2 year warranty. Kit include 2 rubber membrane diffuser and compressor. Tubing sold separately (order 3/8” tubing). Ideal for aerating long narrow pond or 2 small ponds with single compressor. Requires weather protection for compressor. \$979.99



**Roto-Molded Cabinet**

Economical alternative to steel cabinet. Tan color blends well into existing landscape. Built in louvers allow fresh air into cabinet. Cooling fan is recommended for large compressors or in hot locations. Cabinet sold separately \$239.99 without fan \$299.99 with 115v fan

|                                |          |
|--------------------------------|----------|
| Algae Defense Gallon           | \$89.99  |
| Ultra Pond Weed Defense Quart  | \$89.99  |
| Ultra Pond Weed Defense Gallon | \$149.99 |
| Shoreline Defense Quart        | \$89.99  |
| Shoreline Defense Gallon       | \$149.99 |



**Pond VIVE**

The natural, biological way to revive your pond. This special blend of bacteria is designed to reduce sludge buildup, eliminate pond odors, improve water clarity, reduce oxygen demand, eliminate excess nutrients. Pre-measured water soluble packets you just toss in. 2 packets treats ¼ acre new pond for 2 weeks, use 3 packets every 2 weeks for older ponds. 10 lb pail (20 packets) \$149.99

**Barley Pellets**

100% natural from concentrated barley straw. Safe for use with aquatic life and pets. Apply every 6-8 weeks. 40 lb bag treats 1/3 acre \$69.99





# Pond Accents

## Faux Stump

Great for hiding outdoor electrical outlets by the pond or just in the landscape. Can also be used as a decorative accent that is also a seat.

15" diameter, 18.5" height – hollow inside

\$129.99

Faux Stone Propane Cover \$219.99 (not shown)



## Faux Driftwood

Ideal for concealing hard to hide water feature component such as skimmer openings and waterfall weirs. Place anywhere in the landscape as a decorative accent.

32.5"x10"x7.25" \$79.99

36.25"x10.75"x8" \$99.99



## Faux Fish Cave

Protect your pond fish from pesky predators. The Aquascape Faux Log Fish Cave provides pond fish, such as goldfish and koi, shelter from predators such as herons. The natural-looking faux wood design blends well into any setting and can be used for indoor or outdoor use. Add to existing ponds, new ponds, or use as a decorative accent in the garden. The heavy-duty, poly-resin construction is built to last and stand up to the elements. \$119.99

## DekoRRa Faux Rocks

Artificial rocks made with textured material that can be used to hide electrical outlets or just as accent boulders in the landscape without the weight of real rock. Flange around the edge allows you to stake it into ground.



Model 106  
19"x14"x12"  
\$105.99



Model 109  
30"x23"x18"  
\$159.99



## Creatures, Critters and Art

We have a rotating selection of frogs, turtles, humans, fountains and more for you to add to the landscape. Come in to check them out.

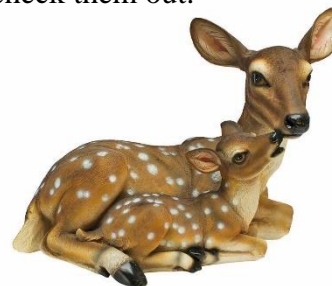

## ***Directions***

157 Central Street  
Rowley, MA 01969

### **From the South**

Route 95 North to Exit 78 (formerly Exit 54). Take Route 133 East to the junction of Route 1. Turn left at Route 1 heading north. Continue 2 miles to 2<sup>nd</sup> traffic light. Take right onto Central Street. We are 1 ½ miles on the left.

### **From the North**

Route 95 south to Exit 78 (formerly Exit 54). Follow directions above. Or take Route 1 South. Approximately 7 miles south of the Newburyport rotary, turn left at the traffic light. (This is after you pass the blinking lights at The Governor's Academy.) We are 1 ½ miles on the left.

### **From the West**

Route 128 to Route 95 North. Follow the directions from the South above

---

***We also offer a full line of annuals, perennials, dwarf shrubs, ornamental grasses, hardy mums and ornamental cabbage and kale for landscaping around your pond.***

***Open Seasonally  
Hours vary by season***

***[www.countrygardens-rowley.com](http://www.countrygardens-rowley.com)***  
***email: [country-gardens@comcast.net](mailto:country-gardens@comcast.net)***